

# REEVALUATION OF BURNER CHARACTERISTICS FOR FIRE RESISTANCE TESTS

James E. Demaree



JANUARY 1977

FINAL REPORT

Document is available to the public through the  
National Technical Information Service  
Springfield, Virginia 22151

Prepared for

**U. S. DEPARTMENT OF TRANSPORTATION**  
**FEDERAL AVIATION ADMINISTRATION**  
Systems Research & Development Service  
Washington, D.C. 20590

1. Report No. FAA-RD-76-213		2. Government Accession No.		3. Recipient's Catalog No.	
4. Title and Subtitle REEVALUATION OF BURNER CHARACTERISTICS FOR FIRE RESISTANCE TESTS				5. Report Date January 1977	
				6. Performing Organization Code	
7. Author(s) James E. Demaree				8. Performing Organization Report No. FAA-NA-76-43	
9. Performing Organization Name and Address Federal Aviation Administration National Aviation Facilities Experimental Center Atlantic City, New Jersey 08405				10. Work Unit No. (TRAIS)	
				11. Contract or Grant No. 181-522-000	
12. Sponsoring Agency Name and Address U.S. Department of Transportation Federal Aviation Administration Systems Research and Development Service Washington, D.C. 20590				13. Type of Report and Period Covered Final September 1975-June 1976	
				14. Sponsoring Agency Code	
15. Supplementary Notes					
16. Abstract  Laboratory evaluations were performed to determine the flame characteristics of the Lennox OB-32 conversion oil burner. Three commercially available burners were modified to produce a flame with characteristics similar to the Lennox OB-32. Various apparatus used in this determination are described in this report. It was concluded that the three burners tested could be modified to produce flame patterns and characteristics comparable to the Lennox OB-32 conversion oil burner.  The burner described in this report has been used to determine the fire resistance of flexible hose assemblies under simulated conditions. The test was aimed at producing a typical aircraft powerplant fire.					
17. Key Words Fire Test                      Flame Burners                         Hose Tests Oil Burners			18. Distribution Statement Document is available to the public through the National Technical Information Service, Springfield, Virginia 22151		
19. Security Classif. (of this report) Unclassified		20. Security Classif. (of this page) Unclassified		21. No. of Pages 41	22. Price

# METRIC CONVERSION FACTORS

Approximate Conversions to Metric Measures				Approximate Conversions from Metric Measures			
Symbol	When You Know	Multiply by	To Find	Symbol	When You Know	Multiply by	To Find
<b>LENGTH</b>							
in	inches	2.5	centimeters	mm	millimeters	0.04	inches
ft	feet	30	centimeters	cm	centimeters	0.4	inches
yd	yards	0.9	meters	m	meters	3.3	feet
mi	miles	1.6	kilometers	km	kilometers	0.6	mi
<b>AREA</b>							
in <sup>2</sup>	square inches	6.5	square centimeters	cm <sup>2</sup>	square centimeters	0.16	square inches
ft <sup>2</sup>	square feet	0.09	square meters	m <sup>2</sup>	square meters	1.2	square yards
yd <sup>2</sup>	square yards	0.8	square meters	km <sup>2</sup>	square kilometers	0.4	square miles
mi <sup>2</sup>	square miles	2.6	square kilometers	ha	hectares (10,000 m <sup>2</sup> )	2.5	acres
<b>MASS (weight)</b>							
oz	ounces	28	grams	g	grams	0.035	ounces
lb	pounds (2000 lb)	0.45	kilograms	kg	kilograms	2.2	pounds
		0.9	tonnes	t	tonnes (1000 kg)	1.1	short tons
<b>VOLUME</b>							
tsp	teaspoons	5	milliliters	ml	milliliters	0.03	fluid ounces
Tbsp	tablespoons	15	milliliters	ml	milliliters	2.1	pints
fl oz	fluid ounces	30	milliliters	l	liters	1.06	quarts
c	cups	0.24	liters	l	liters	0.26	gallons
pt	pints	0.47	liters	m <sup>3</sup>	cubic meters	35	cubic feet
qt	quarts	0.95	liters	m <sup>3</sup>	cubic meters	1.3	cubic yards
gal	gallons	3.8	liters				
ft <sup>3</sup>	cubic feet	0.03	cubic meters				
yd <sup>3</sup>	cubic yards	0.76	cubic meters				
<b>TEMPERATURE (exact)</b>							
°F	Fahrenheit temperature	5/9 (after subtracting 32)	Celsius temperature	°C	Celsius temperature	9/5 (then add 32)	Fahrenheit temperature

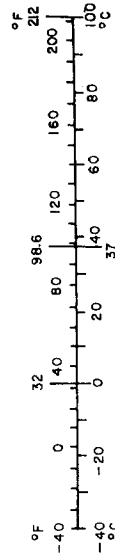
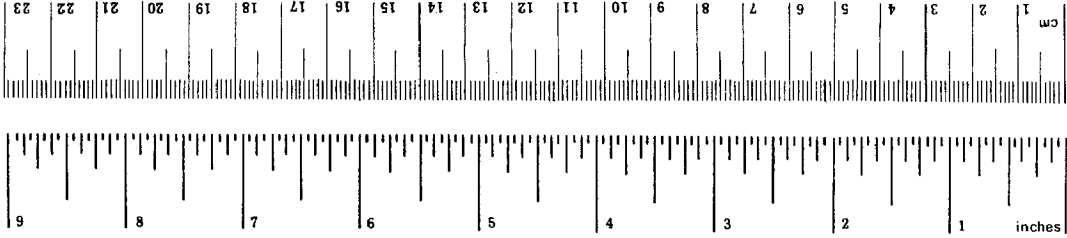

\* 1 in = 2.54 (exact). For other exact conversions and more detailed tables, see NBS Misc. Publ. 286, Units of Weights and Measures, Price \$2.25, SD Catalog No. C13.10-286.

## PREFACE

Contributions by Dr. Thor Eklund and Mr. Constantine Sarkos in the areas of heat transfer and thermal characteristics of flame were essential to the data analysis phase of this program. Mr. William Neese provided valued assistance in the development and design of the mechanical systems.

## TABLE OF CONTENTS

	Page
INTRODUCTION	1
Purpose	1
Objectives	1
Background	1
DISCUSSION	1
Test Environment	1
Data Collection System/Procedures	1
TEST RESULTS AND ANALYSIS	3
Lennox OB-32	3
Carlin 200 CRD	3
Stewart-Warner Model HPR 250	5
Stewart-Warner Model FR-600	6
AMAL Atmospheric Injectors	6
Test Apparatus	7
Burner Standardization Apparatus	8
SUMMARY OF RESULTS	8
CONCLUSIONS	10
REFERENCES	10
APPENDIX - Equipment Specifications	

## LIST OF ILLUSTRATIONS

Figure		Page
1	Schematic of Test Area	11
2	Test Burner Standardization Apparatus	12
3	Calorimeter and Traversing Mechanism	13
4	Typical Total Thermal Energy Profile	14
5	Thermocouple Rake	15
6	Instrument Systems (Data Collection and Recording)	16
7	Oxygen Concentration Analyzer System	17
8	Oxygen Sensing Probe	18
9	Lennox OB-32 Conversion Oil Burner	19
10	Lennox OB-32 Temperature Profile	20
11	Carlin 200 CRD Conversion Oil Burner	21
12	Air Tube Reducing Cone	22
13	Burner Tube Extension	23
14	Carlin 200 CRD Temperature Profile	24
15	Stewart-Warner HPR-250 Conversion Oil Burner	25
16	Stewart-Warner HPR-250 Temperature Profile	26
17	Stewart-Warner FR-600 Conversion Oil Burner	27
18	Stewart-Warner FR-600 Temperature Profile	28
19	AMAL 17 Torch Arrangement	29
20	AMAL 17 Torch Temperature Profile	30
21	AMAL 15 Torch Arrangement	31
22	AMAL 15 Torch Temperature Profile	32
23	AMAL Periphery Btu/ft <sup>2</sup> /s Profile	33
24	Effect of Soot and Carbon Buildup on the 1/2-Inch Heat Transfer Tube	34

## INTRODUCTION

### PURPOSE.

The purposes of this project were to (1) reaffirm and/or modify, if necessary, preestablished flame properties of the Lennox model OB-32 conversion oil burner and the test procedures required to define same, and (2) qualify any additional flame-producing apparatus required in the fire testing of flexible hose assemblies.

### OBJECTIVES.

The objectives were to determine and define the flame characteristics produced by the Lennox model OB-32 conversion oil burner, the criteria to be used to characterize the flame, the equipment and procedures to be used in this determination, and the burners that may be used in lieu of the Lennox OB-32.

### BACKGROUND.

Since 1961, the Federal Aviation Administration (FAA) has accepted the fire test procedures described in Power Plant Engineering Report No. 3 (reference 1) to fire test flexible hose assemblies used in aircraft powerplant installations. The burner described in the report is no longer commercially available and is the main reason for the work effort described in this report.

## DISCUSSION

### TEST ENVIRONMENT.

The test compartment shown in figure 1 was developed and fitted with a 30-inch-square duct, 4 feet long, providing a "ducted hood" to funnel the products of combustion given off by the test burners. An exhaust fan provided an airflow through this duct of 400 feet per minute (ft/min), as required in reference 1.

### DATA COLLECTION SYSTEMS/PROCEDURES.

1. The burner standardization apparatus as described in reference 1 was modified in two areas; (1) as shown in figure 2, the thermometers were replaced with two iron constantan immersible thermocouples to measure the inlet and outlet water temperature and provide a signal input to data recording system, and (2) the water reservoir was replaced with a pressure-regulated water supply. It was experimentally determined that changing the specified 5-foot head of water supply to a nominal 50-pounds-per-square-inch gage (psig) water supply had no influence in heat transfer. Temperature data were taken at 10-second intervals over a period of 2 minutes. The waterflow for this 2-minute period

was collected in a container and weighed at the end of each period. The heat transfer, British thermal units/hour (Btu/h), to the 1/2-inch tube, as described in reference 1, was derived by multiplying the water temperature heat rise in degrees Fahrenheit (F) times the rate of water flow in pounds/hour (lb/h).

2. The Hy-Cal, watercooled, Asymptotic<sup>®</sup> calorimeter used was rated at 30 Btu's per square foot per second (Btu/ft<sup>2</sup>/s) total thermal energy. Radiant heat and convective heat are combined to give a total heat value. The Hy-Cal calorimeter was mounted on a remotely controlled traverse mechanism (figure 3) that provided 6 3/4 inches of vertical movement and a total of 22 inches of horizontal movement at a rate of 0.42 inch per second. The millivolt output signal from the calorimeter was recorded on the Esterline Angus single-channel recording servo. The recorded continuous value was integrated, and an average Btu/ft<sup>2</sup>/s value was obtained for each horizontal traverse. These values for each 1-inch vertical increment were then totaled and averaged for each flame pattern and are cited in the text. A typical calorimeter recording is shown in figure 4.

3. The thermocouple rake shown in figure 5 consisted of eleven 1/16-inch, type K, grounded Ceramocouples<sup>®</sup> with a nominal 30 American wire gage (AWG)-size conductor, manufactured by the Thermo-Electric Company, mounted on a traverse mechanism 1-inch apart, and remotely controlled to provide 6 3/4 inches of vertical movement. The output of these Ceramocouples was recorded on an Esterline Angus D-2020 Data Acquisition System shown in figure 6. The 11 channels of flame temperature measurement permitted a total scan across one horizontal plane in 5 seconds. Any vertical position could be selected, but the major effort of flame temperature measurement was at 1-inch vertical increments.

4. The Beckman model 715 oxygen process analyzer shown in figure 7 measures the volumetric oxygen concentration by the diffusion of oxygen through a gas-permeable membrane and an electrochemical reaction producing a current flow proportional to the partial pressure of the oxygen in the sample stream. The probe for this system was mounted on the calorimeter traverse mechanism shown in figure 8. The electrical output signal from the analyzer was amplified and read directly in volumetric percent on a meter and recorded on the single-pen servo recorder. All sensors (thermocouples, calorimeter, oxygen, and 1/2-inch tube) were positioned 4 inches forward of the burner tube extension.

5. The Hastings air meter and N-78 probe is a thermopile anemometer with a visual readout in feet per minute or miles per hour. The system was used to periodically monitor the airflow through the 30-inch-square duct.

6. The Esterline Angus D-2020 Data Acquisition System shown in figure 5 is a 20-channel, programmable, digital printout system capable of recording and printing either millivolt or temperature in degrees Fahrenheit. The system is capable of recording 2.5 channels per second, but consistently recorded the 11 flame temperatures in 5 seconds. This system was used to record flame temperatures in degrees Fahrenheit and water temperatures in millivolts through a 32° F reference junction and converted to degrees Fahrenheit.



7. The Esterline Angus recording servo, shown in figure 6 is a single-channel, multimillivolt input, variable-speed recorder and was utilized to record the output of the Hy-Cal calorimeter and the Beckman oxygen analyzer. The system accuracy is rated at +0.5 percent of full-scale span. Specifications of the equipment is listed in the appendix.

## TEST RESULTS AND ANALYSIS

### LENNOX OB-32.

The replacement of the Lennox OB-32 conversion oil burner, figure 9, necessitated a complete evaluation of the flame characteristics produced by the burner. The burner was set up to the specifications outlined in reference 1. The burner contained a 2.25 gallon-per-hour (gal/h) 80° nozzle operating at a pressure of 85 psig, delivering 2.03 gal/h. Air pressure in the air tube, sometimes referred to as draft tube, or burner tube, was adjusted to 0.17 inch of water (H<sub>2</sub>O). The best temperature profile obtained with this configuration is shown in figure 10. The 4,500 Btu/hr value referred to in reference 1 was slightly exceeded as shown in table 1. The Btu/ft<sup>2</sup>/s survey made by the Hy-Cal calorimeter indicated that the average total thermal energy for the flame ranged from 9.8 to 10.8 Btu/ft<sup>2</sup>/s. Oxygen volumetric concentration within the flame ranged from 5 percent to 11 percent.

The controlling characteristics of the flame are as follows:

1. Temperature measurements through the horizontal centerline should indicate 2,000 ±150° F for a distance of not less than 7 inches as measured with the thermocouples described.
2. Total heat transfer to the 1/2-inch tube should not be less than 4,500 Btu/hr nor greater than 4,650 Btu/hr.
3. The total thermal energy as indicated by the calorimeter should average between 9.8 (+1.5/-0.5) to 10.8 (±1.0) Btu/ft<sup>2</sup>/sec.
4. Oxygen concentration is not considered a factor in characterizing the flame.

CARLIN 200 CRD. The first of the candidate burners, manufactured by the Carlin Company, 912 Silas Deane Highway, Wethersfield, Connecticut 06109, shown in figure 11, was modified in the following manner to produce a diffused 6-inch (vertical) by 11-inch (horizontal) sized flame with homogeneous temperature gradient.

1. An 80° fuel nozzle rated at 2.25 gal/h and pressure adjusted to deliver 2.04 gal/h at 97 psig was installed.
2. The retention and throttle rings plus the support and forward extension were removed.

TABLE 1. BURNER SPECIFICATIONS AND PERFORMANCE

Burner	Rated Fuel Flow Capacity gal/hr	Motor	Blower Wheel (inches)	Fuel Pump	Tube Extension (inches)	Heat Transfer to 1/2-in. Tube	Total Thermal Energy (Btu/ft <sup>2</sup> /s)	Flame Oxygen Concentration (percent)
Lennox OB-32		1/4 hp	3 5/8	Two Stage	4x12	4,574	9.8-10.8	5-11
		1,725 r/min	6 1/8					
Carlin 200 CRD	2.0-5.0 gal/hr	1/4 hp	3 1/2	Single Stage	4 1/8x11	4,545	9.3-11.2	6.5-8.5
		3,450 r/min	5 1/4					
Stewart Warner HPR-250	1.35-2.50 gal/hr	1/7 hp	3 9/16	Single Stage	4x13 5/32	4,646	9.3-10.1	9.2-9.5
		3,450 r/min	5 3/8					
Stewart Warner FR-600	2.0-6.0 gal/hr	1/3 hp	3 15/16	Two Stage	4x12 7/8	4,466	9.9-10.9	8.5-15.2
		3,450 r/min	6 1/32					
AMAL 17	NA	MODEL 354/27 LV	NA	NA	NA	5,858	6.7-7.7	1.7-3.1
AMAL 15	NA	MODEL 354/27 LV	NA	NA	NA	4,945	6.1-7.1	1.5-2.5

NA = Not Applicable

3. A flat-plate disc, approximately 4 inches in diameter and randomly punched with ten 1/2-inch holes, was installed 4 inches aft of the fuel nozzle tip. This provided support and centering of the oil delivery tube.
4. The air tube diameter was decreased to 2 1/2 inches starting 1 1/2 inches forward of the fuel nozzle tip. The reducing cone is shown in figure 12.
5. Two 1/16-inch-thick by 3/4-inch-wide stainless steel fuel deflectors were installed at the 3 and 9 o'clock positions with their ends 5/8 inch from the fuel nozzle centerline and 3/4 inch forward of the fuel nozzle tip. A 1-inch-wide stainless steel fuel deflector (1/16 inch thick) was installed at the 12 o'clock position with its edge 3/4 inch forward of the fuel nozzle tip and 3/4 inch above the fuel nozzle centerline.
6. A static pressure port was installed 1 inch forward of the air tube mounting flange.
7. A 12 1/2-inch burner extension (reference 1) shown in figure 13 was added to the end of the burner air tube. The extension was installed on the air tube so that the wide end was 10 inches beyond the end of the air tube. The air pressure was adjusted to indicate 0.37 inch H<sub>2</sub>O air tube pressure.

The temperature profile obtained with this burner configuration is shown in figure 14. A heat transfer rate of 4,545 Btu/h to the 1/2-inch tube was obtained as shown in table 1, and the Hy-Cal calorimeter measured an average range from 9.3 to 11.2 Btu/ft<sup>2</sup>/s. Oxygen volumetric concentration within the flame ranged from 6.5 percent to 8.5 percent.

#### STEWART-WARNER MODEL HPR 250.

The second candidate burner, manufactured by the Stewart-Warner Corporation, Heating and Air Conditioning Division, Lebanon, Indiana 46052, figure 15, was modified in the following manner to produce a diffused 6-inch (vertical) by 11-inch (horizontal) size flame with homogeneous temperature gradient:

1. An 80° fuel nozzle rated at 2.25 gal/h and pressure adjusted to 95 psig and delivering 2.04 gal/h was installed.
2. The air cone assembly was removed.
3. The air tube diameter was reduced to 2 1/2 inches starting 1 1/2 inches forward of the fuel nozzle tip with the addition of the reducing cone shown in figure 12.
4. Four 1/16-inch by 3/4-inch stainless steel fuel deflectors were mounted on the reducing cone at 3, 6, 9 and 12 o'clock positions. The deflector edges were 3/4 inch from the fuel nozzle centerline and 3/4 inch forward of the fuel nozzle tip.
5. A static air-pressure port was installed 1-inch forward of the burner tube mounting flange.

6. A 12 1/2-inch burner extension (reference 1) shown in figure 13 was added to the end of the burner air tube. The extension was installed so that the wide end was 10 inches beyond the end of the air tube. Air pressure in the tube was adjusted to 0.14 inch H<sub>2</sub>O.

The temperature profile shown in figure 16 was obtained with this configuration, and a heat transfer rate of 4,646 Btu/h to the 1/2-inch tube was obtained as shown in table 1. The Hy-Cal calorimeter measured an average range from 9.3 to 10.1 Btu/ft<sup>2</sup>/s. The O<sub>2</sub> concentration, measured through the horizontal centerline of the flame, fluctuated from 9.2 percent to 9.5 percent in the flame center. Two inches from each side, the O<sub>2</sub> concentration increased to 11 percent and 15 percent, respectively. This burner had the tendency to burn richer at the outer edges of the flame, as observed visually and confirmed by O<sub>2</sub> concentration measurements.

#### STEWART-WARNER MODEL FR-600.

The third candidate burner, as shown in figure 17, was modified in the following manner to produce a diffused 6-inch (vertical) by 11-inch (horizontal) size flame with homogeneous temperature gradient.

1. An 80° fuel nozzle rated at 2.25 gal/h and pressure adjusted to deliver 2.03 gal/h at 100 psig was installed.
2. The flame retention hood assembly was removed.
3. The air tube diameter was decreased to 2 1/2 inches starting 1 1/2 inches forward of fuel nozzle tip, with the reducing cone as shown in figure 12.
4. Four 1/16-inch by 3/4-inch stainless steel deflectors were mounted on the reducing cone at 3, 6, 9, and 12 o'clock positions. The deflector edges were adjusted to within 3/4 inch from the fuel nozzle centerline and 1 1/2 inch forward of the fuel nozzle.
5. A 12 1/2-inch burner extension (reference 1) shown in figure 13 was added to the end of the burner air tube. The extension was installed so that the wide end was 10 inches beyond the end of the air tube. Air pressure in the tube was adjusted to 0.01-inch H<sub>2</sub>O. The static disc and the flame detector were not altered.

Temperature profile obtained with this configuration is shown in figure 18. A heat transfer rate of 4,466 Btu/h to the 1/2-inch tube was obtained as shown in table 1. The Hy-Cal calorimeter measured an average range from 9.9 to 10.9 Btu/ft<sup>2</sup>/s. Volumetric O<sub>2</sub> concentrations within the flame ranged from 8.5 percent to 15.2 percent.

#### AMAL ATMOSPHERIC INJECTORS.

The fourth candidate burner, manufactured by AMAL LTD., Birmingham, England, was evaluated as a liquid petroleum gas (propane) torch. Seventeen unmodified torches were mounted on a bracket to form a cluster of torches approximately

6 inches by 12 inches as shown in figure 19. Propane gas was supplied to these torches through a manifold assembly and regulated through a pressure range from 10 psig to 21 psig. The fuel/air ratio was regulated by changing the position of the venturi. The torches were adjusted so that just a trace of yellow showed in the otherwise blue flame. The temperature profile recorded with this adjustment and with the propane pressure regulated at 21 psig is shown in figure 20. A heat transfer rate of 5,858 Btu/h to the 1/2-inch tube was obtained as shown in table 1, and the Hy-Cal calorimeter measured an average range from 6.7 to 7.7 Btu/ft<sup>2</sup>/s. Volumetric O<sub>2</sub> concentrations within the flame ranged from 1.7 percent to 3.1 percent.

A second series of tests were conducted with the unmodified AMAL torches, this time with the two outside torches of the top row removed, as shown in figure 21. This was an attempt to lower the temperature and Btu value of the top half of the clustered torches. The temperature was reduced on the top row of the torches, and the heat value transferred to the 1/2-inch tube was reduced to 4,945 Btu/h. The removal of the two torches had a greater effect on the Btu/ft<sup>2</sup>/s value, reducing the average range of 6.1 to 7.1 Btu/ft<sup>2</sup>/s. The temperature profile is shown in figure 22. Volumetric O<sub>2</sub> concentrations within the flame ranged from 1.5 percent to 2.5 percent.

One of the unmodified AMAL torches was evaluated with the calorimeter to determine its individual performance. This evaluation was performed as a bench test. With the calorimeter positioned 4 inches from the end of the torch, 8.3 to 8.7 Btu/ft<sup>2</sup>/s were recorded. The calorimeter was moved to 2 inches from the end of the torch, and the total thermal energy ranged from 12.1 to 12.5 Btu/ft<sup>2</sup>/s. A series of tests to determine the total thermal energy profile (periphery) was conducted by moving the calorimeter 1 inch and then 2 inches from the torch nozzle centerline. These data are shown in figure 23.

Tests were also conducted to determine the Btu/ft<sup>2</sup>/s output of a torch modified with an 11-inch extension as described in the British Standards Institution document 72/35908 (reference 2). Data recorded on the centerline of this modified torch indicated 27.7 to 27.8 Btu/ft<sup>2</sup>/s at the 2-inch distance. At 4 inches, this value was in the range of 23.7 to 25.2 Btu/ft<sup>2</sup>/s. The total thermal energy profile for this modified torch 1 inch and 2 inches off the centerline is also shown in figure 23.

#### TEST APPARATUS.

The mobile and remotely controlled data collection system allowed a more complete analysis of flame characteristics than had been obtained to date. The temperature-indicating system permitted an 11-point horizontal survey at 1-inch increments across the flame at any selected vertical height. The capability of the temperature-sensing system allowed the placement of the thermocouples to be repeated within  $\pm 1/8$  inch. Due to erratic flame movement, flame temperature measurement was not repeatable, and  $\pm 200^\circ$  F variation was common.

The influence of the airflow through the duct on temperature measurement was significant. Originally, attempts were made to measure flame temperatures with no controlled airflow over the burners. The flame patterns were very erratic and susceptible to changing air currents and velocities.

#### BURNER STANDARDIZATION APPARATUS.

The effect of carbon buildup on the 1/2-inch tube is a significant factor when the flame is burning rich. Figure 24 presents data gathered to verify this factor. After a 500-lb/h waterflow was established, the burner and temperature data collection were started at time zero. The heat transfer to the 1/2-inch tube started to decrease after approximately 2 minutes for the HPR-250, and after 3 to 4 minutes for the Carlin 200 CRD. The 1/2-inch tube was cleaned, and the tests repeated, with similar results. This does not alter the flame characteristics, but rather the capability of this type of heat transfer apparatus to give valid heat transfer data over a prolonged period of time.

#### SUMMARY OF RESULTS

1. The Lennox OB-32 oil burner produced a 6-inch by 11-inch flame pattern that (a) transferred a minimum of 4,574 Btu/h to the 1/2-inch tube; (b) produced 9.8 to 10.8 Btu/ft<sup>2</sup>/s average total thermal energy values, and (c) contained an oxygen concentration ranging from 5 to 11 percent.
2. The Carlin 200 CRD oil burner produced a 6-inch by 11-inch flame pattern that (a) transferred a minimum of 4,545 Btu/h to the 1/2-inch tube, (b) produced 9.3 to 11.2 Btu/ft<sup>2</sup>/s value, and (c) contained an oxygen concentration ranging from 6.5 percent to 8.5 percent.
3. The Stewart-Warner HPR-250 oil burner produces a 6-inch by 11-inch flame pattern that (a) transferred 4,646 Btu/h to the 1/2-inch tube, (b) produced 9.3 to 10.1 Btu/ft<sup>2</sup>/s value, and (c) contained an oxygen concentration ranging from 9.2 to 9.5 percent.
4. The Stewart-Warner FR-600 oil burner produced a 6-inch by 11-inch flame pattern that (a) transferred a minimum of 4,466 Btu/h to the 1/2-inch tube, (b) produced 9.9 to 10.9 Btu/ft<sup>2</sup>/s value, and (c) contained an oxygen concentration ranging 8.5 percent to 15.2 percent.
5. The 17 clustered AMAL propane torches produced a 7-inch by 12-inch flame pattern that (a) transferred a minimum of 5,858 Btu/h to the 1/2-inch tube, (b) produced 6.7 to 7.7 Btu/ft<sup>2</sup>/s value, and (c) contained an oxygen concentration of 1.7 to 3.1 percent.
6. The 15 clustered AMAL propane torches produced a 7-inch by 12-inch flame pattern that (a) transferred a minimum of 4,945 Btu/h to the 1/2-inch tube, (b) produced 6.1 to 7.1 Btu/ft<sup>2</sup>/s value, and (c) contained an oxygen concentration ranging from 1.5 to 2.5 percent.

7. The burner standardization apparatus operated satisfactorily in conjunction with a pressure-regulated water supply in lieu of the static head system specified in reference 1.

8. The Ceramocouple<sup>®</sup> type thermocouple performed satisfactorily and was a reliable and durable temperature sensor.

9. The calorimeter performed an essential function by defining a flame's total radiant and convective heat flux and the effect that (burning gas) velocity can have on heat flux.

10. The measurement of volumetric oxygen concentration within a flame proved to be reliable and repeatable, but did not indicate usable data to characterize the flame. The data only indicated that concentration that was present in the flame after temperature and heat transfer values were established.

11. Data obtained from the burner standardization apparatus, thermocouple rake, calorimeter, and the oxygen probe for the burners tested were stable and repeatable when measured on the horizontal centerline of the flame (side view) and along a line 4 inches from the end of the burner extension (top view), as compared to data recordings above and below the centerline.

12. The flame temperature of 2,000° F specified in reference 1, was clearly not uniform through the flame frontal area for the burners tested.

## CONCLUSIONS

Based on data analysis and test results, it is concluded that:

1. The Carlin 200 CRD, Stewart-Warner HPR-250, and the Stewart-Warner FR-600 burners are capable of being modified to produce flame patterns and characteristics comparable to the Lennox OB-32 burner.
2. Utilization of the burner standardization apparatus described in reference 1 is still valid as one of the primary test procedures. Comparable data indicate that thermal energy transfer to the 1/2-inch tube is a function of flame intensity.
3. The Ceramocouple or equivalent type thermocouple can be used for the flame temperature apparatus.
4. The calorimeter is necessary in determining the total thermal energy if the overall flame size is different than the described 6-inch by 11-inch size. Example: If the flame size is larger and produces 4,500-Btu/h transfer to the 1/2-inch tube and indicated an overall  $2,000^{\circ}\text{F} \pm 150^{\circ}\text{F}$ , the average Btu/ft<sup>2</sup>/s value will be lower; if the temperature and heat transfer conditions are the same with a smaller size flame the Btu/ft<sup>2</sup>/s will be higher.
5. The volumetric oxygen concentration apparatus is not an essential test apparatus for characterizing a flame.
6. The data-sensing probes for characterizing a flame should be positioned on the centerline of the flame (side view) and be mobile along a line 4 inches from the end of the burner extension.
7. The total flame pattern areas (6-inch by 11-inch or 7-inch by 12-inch) should be measured at 1-inch horizontal and vertical increments. Data so collected provide adequate flame characterization.

## REFERENCES

1. Federal Aviation Administration, Bureau of Flight Standards, Power Plant Engineering Report No. 3 (Revised), Standard Fire Test Apparatus and Procedure for Flexible Hose Assemblies, March 1961.
2. British Standards Institution (BSI) Document 72/35908, Aerospace Series Specification for General Requirements for Equipment in Aircraft, August 1972.



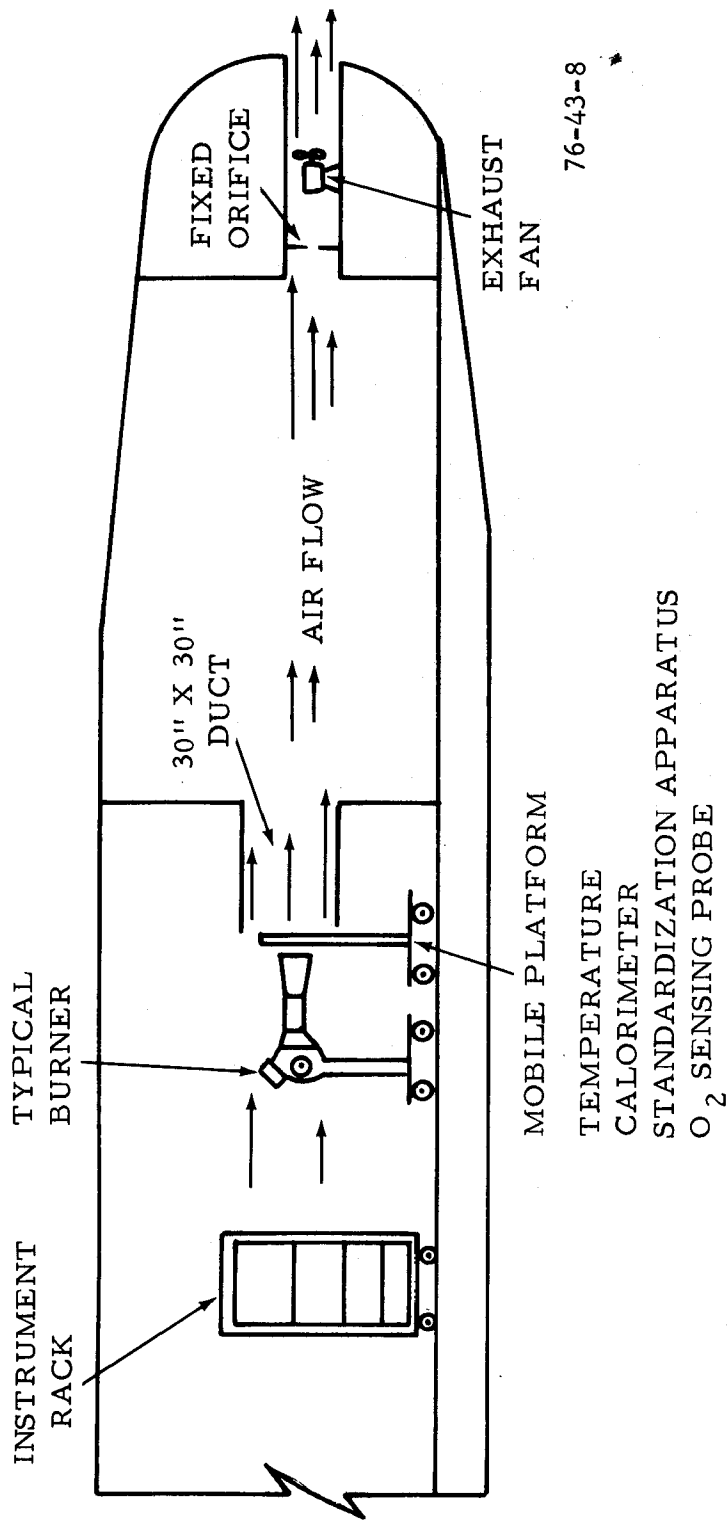

FIGURE 1. SCHEMATIC OF TEST AREA

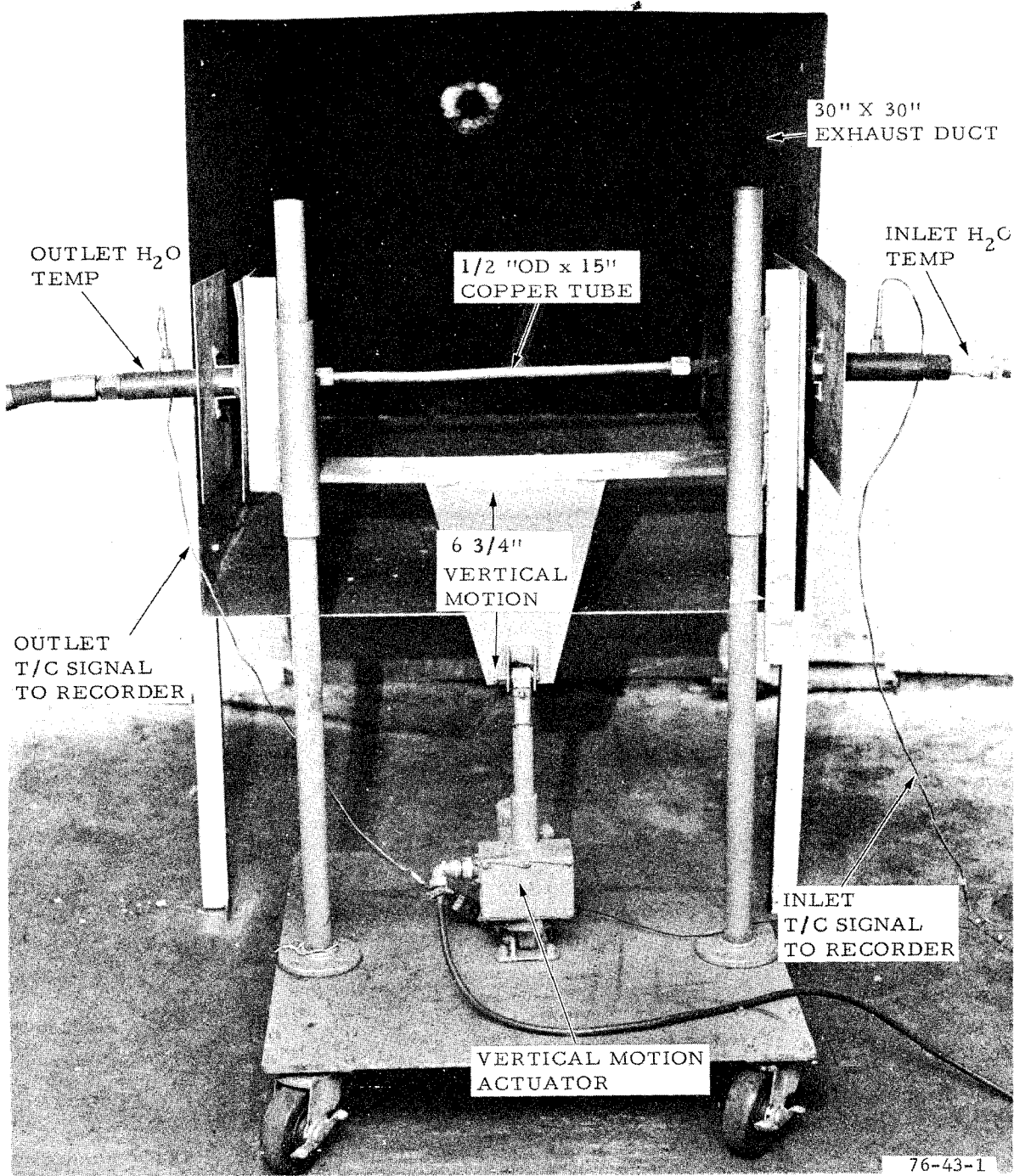

FIGURE 2. TEST BURNER STANDARDIZATION APPARATUS

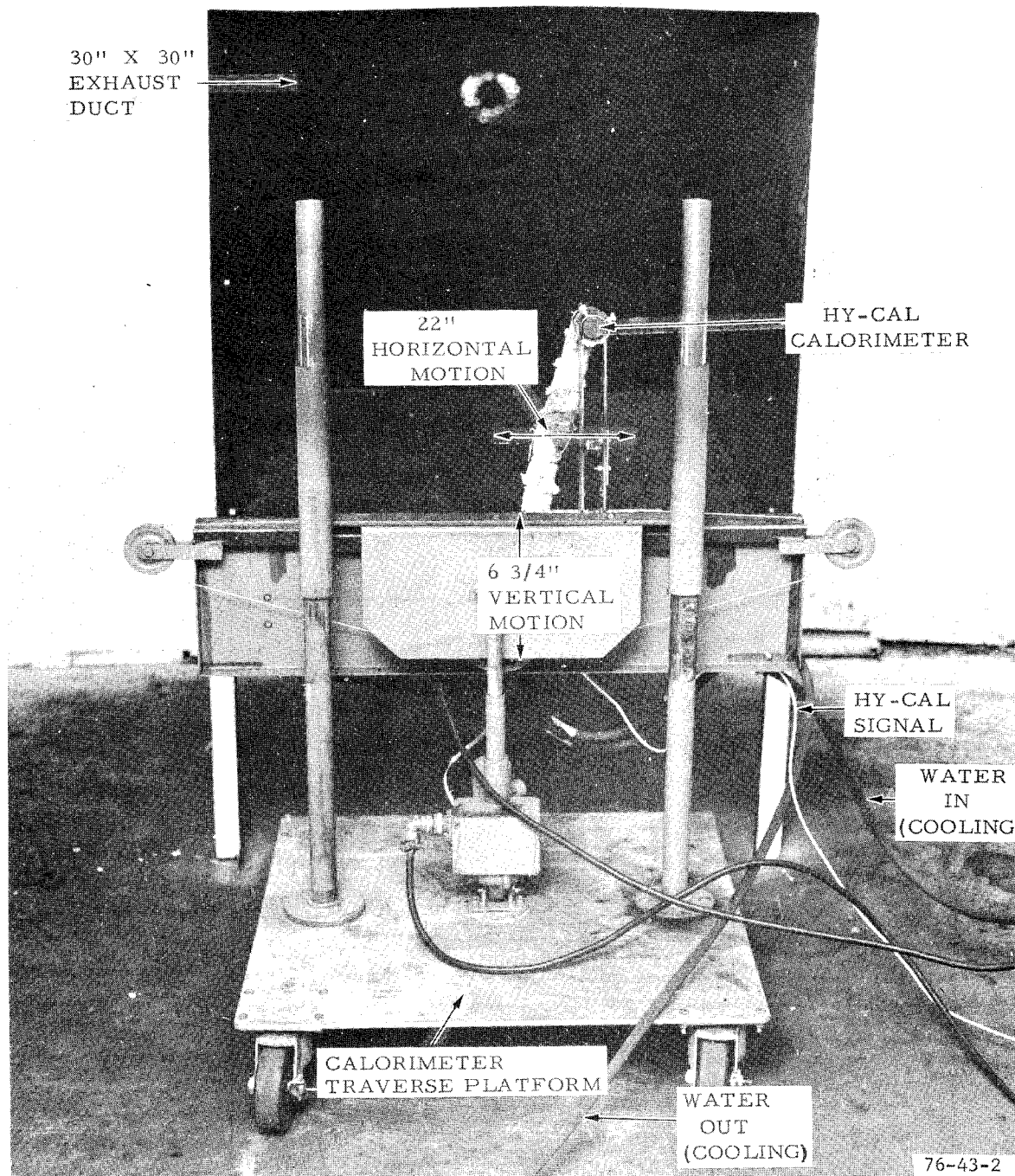

FIGURE 3. CALORIMETER AND TRAVERSING MECHANISM

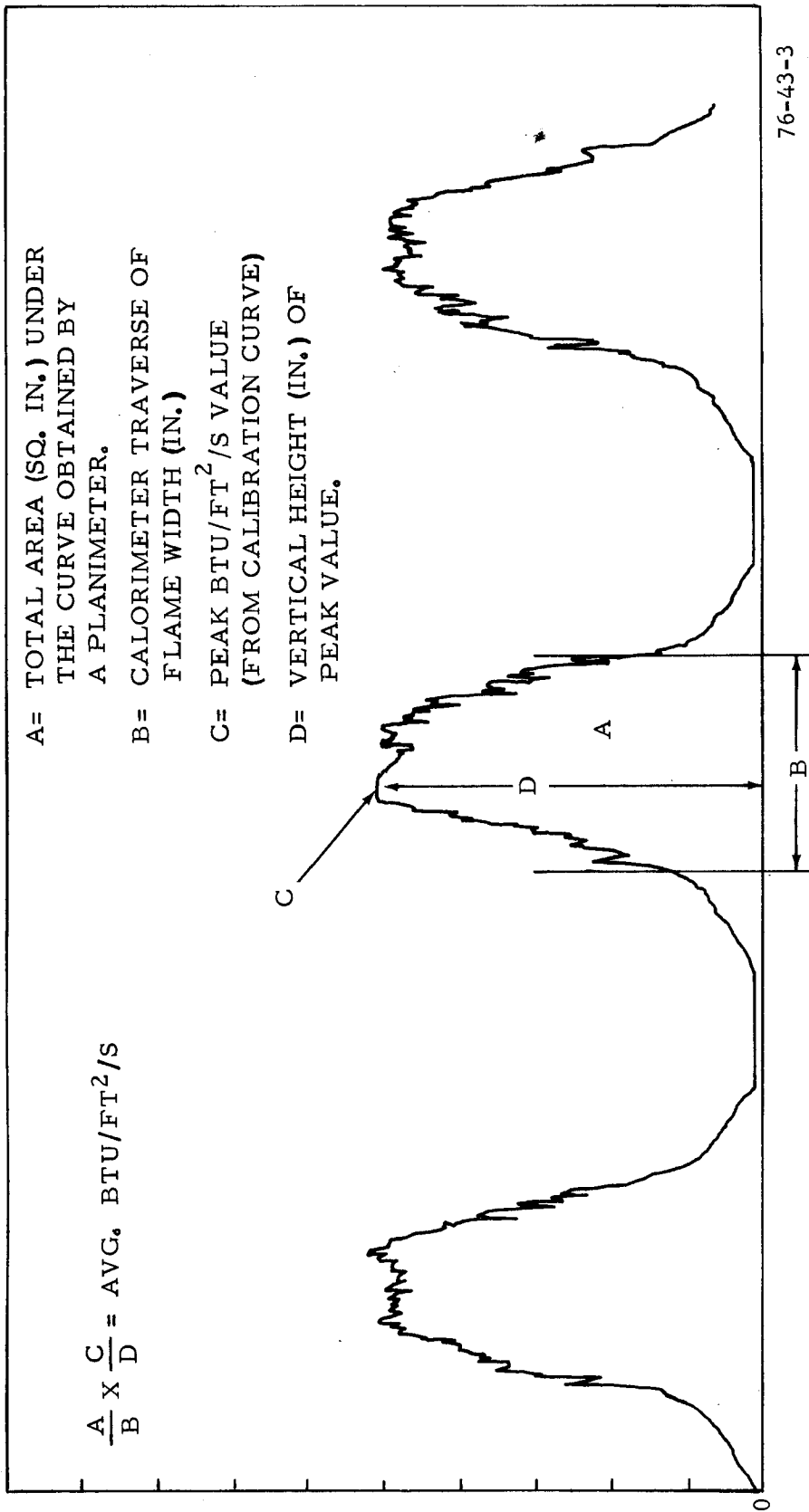

FIGURE 4. TYPICAL TOTAL THERMAL ENERGY PROFILE

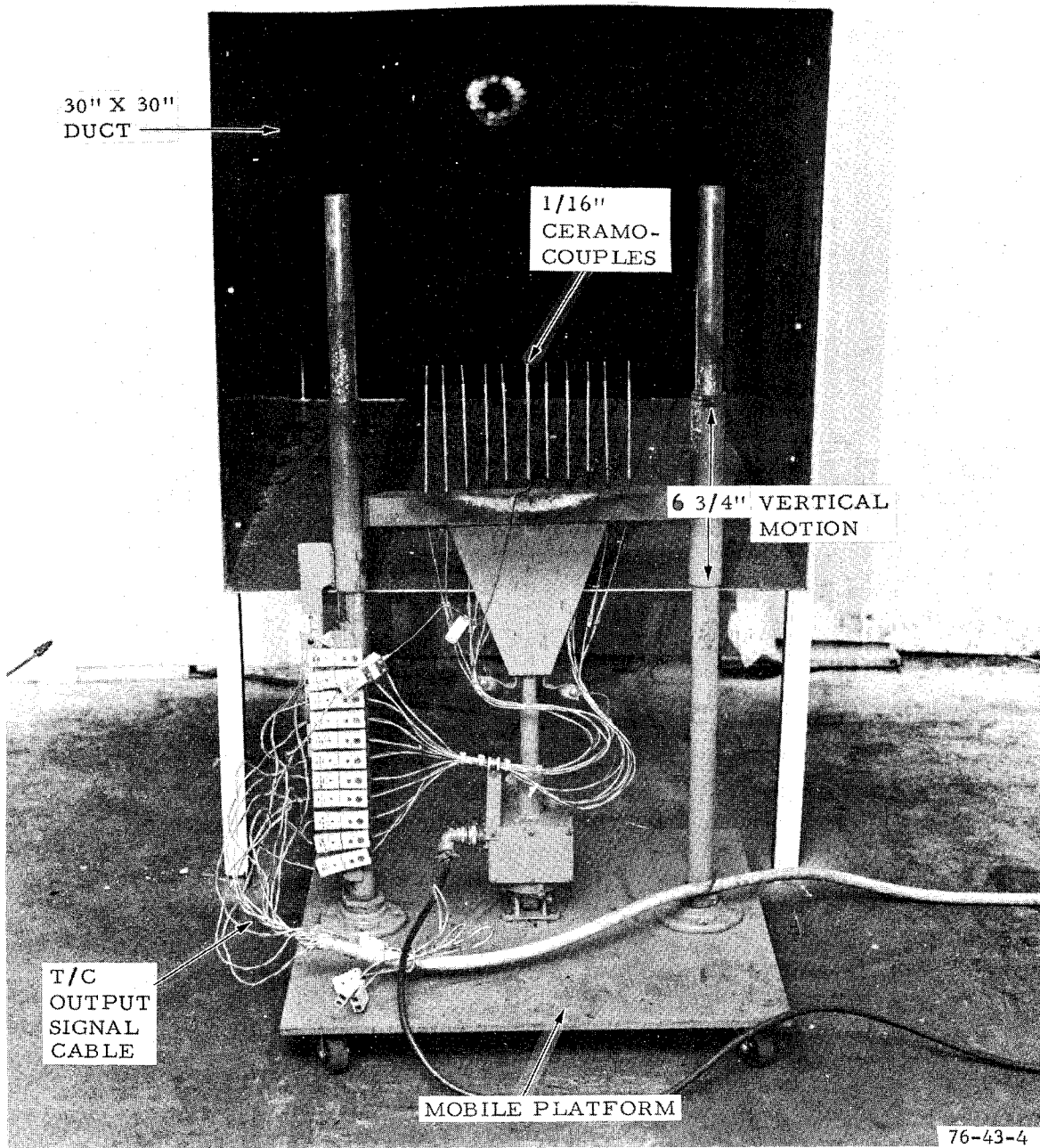

FIGURE 5. THERMOCOUPLE RAKE

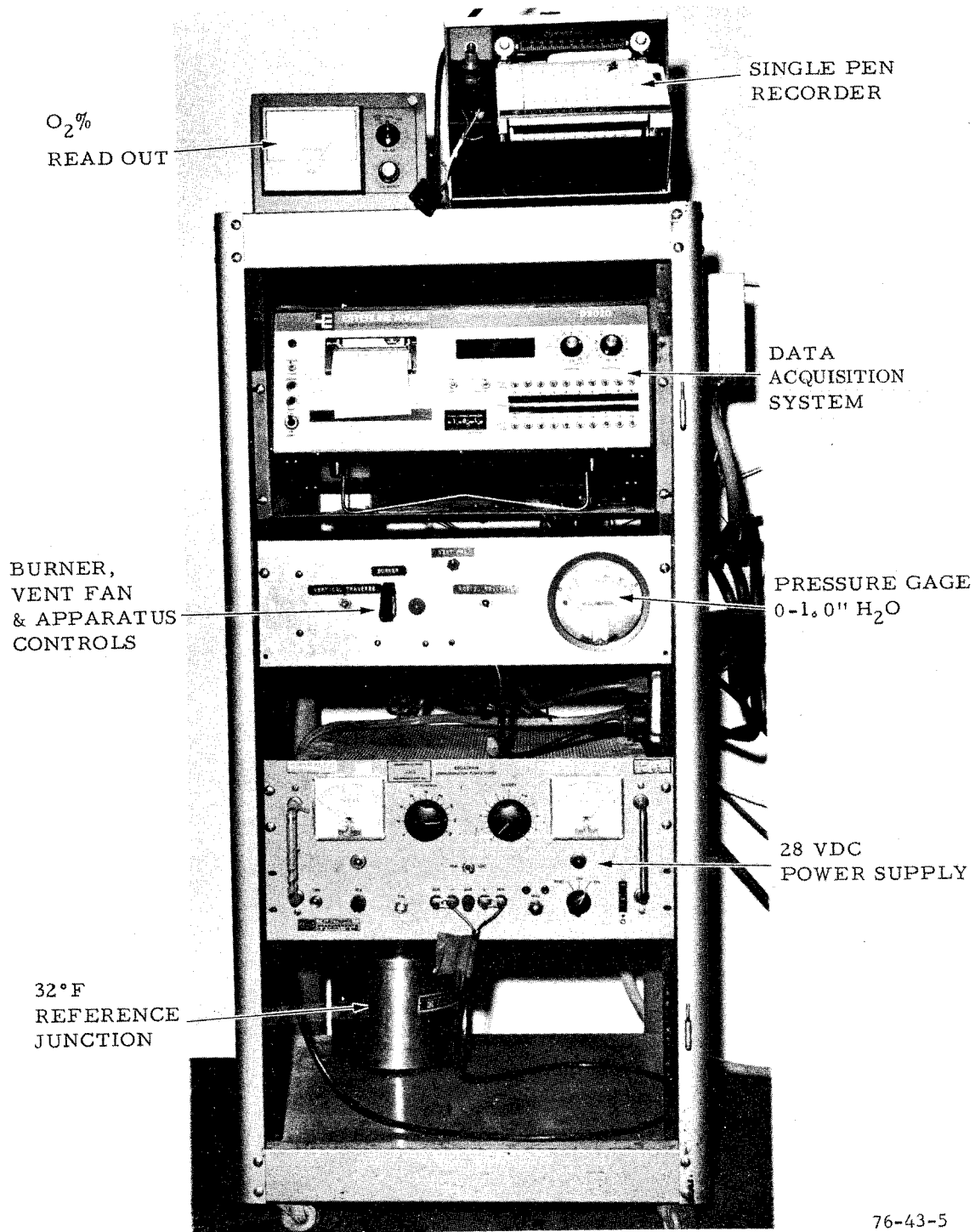

FIGURE 6. INSTRUMENT SYSTEMS (DATA COLLECTION AND RECORDING)

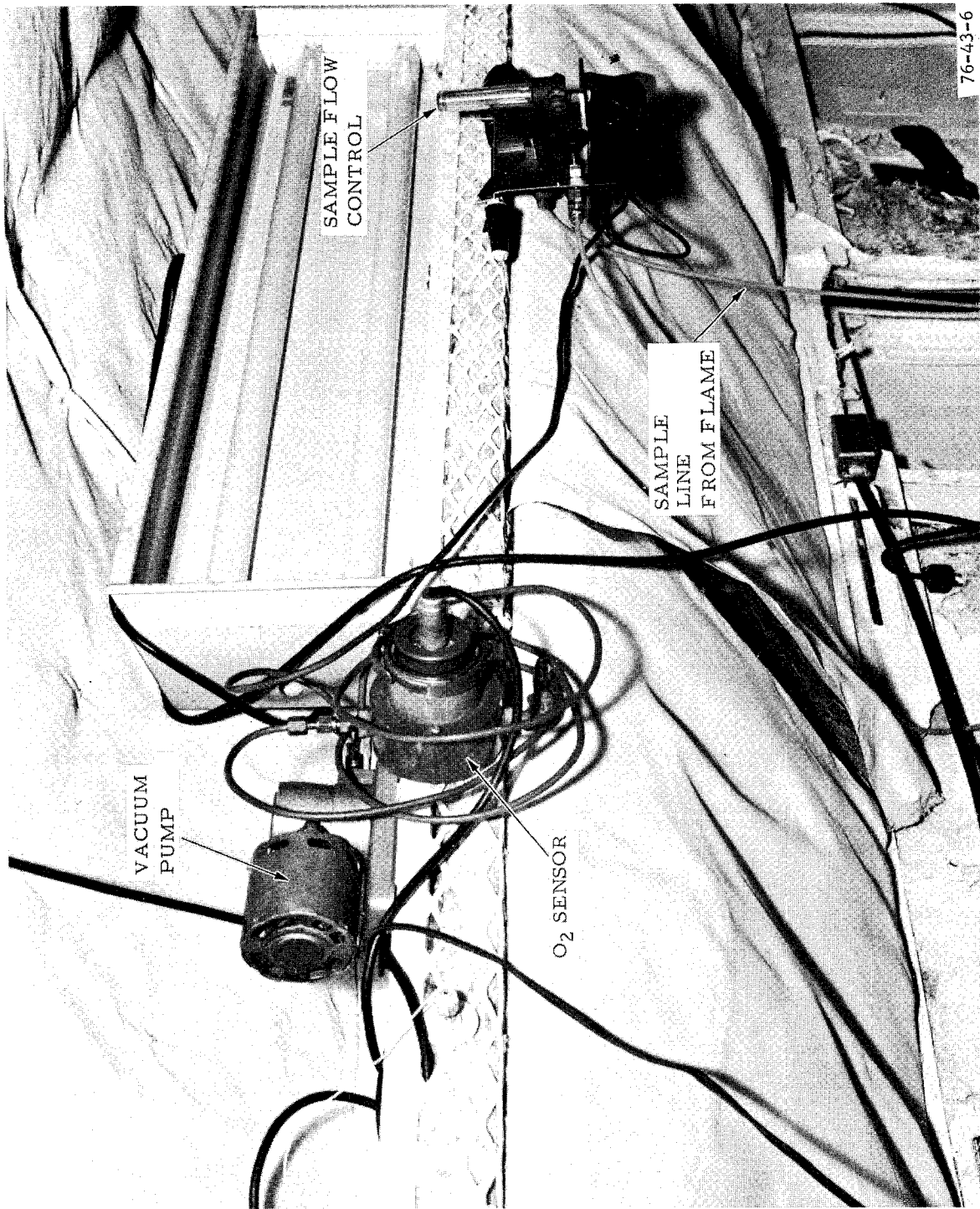

FIGURE 7. OXYGEN CONCENTRATION ANALYZER SYSTEM

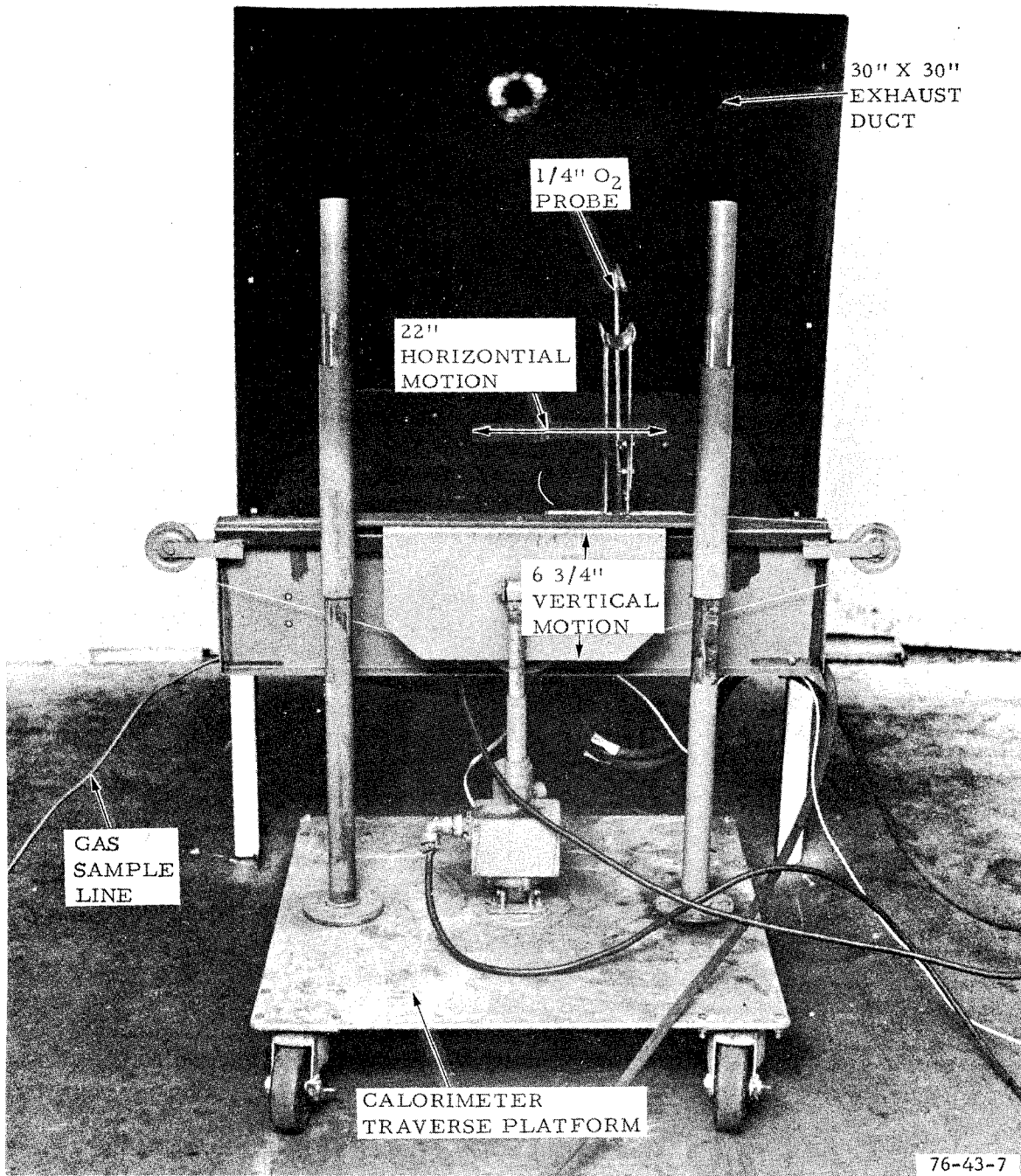
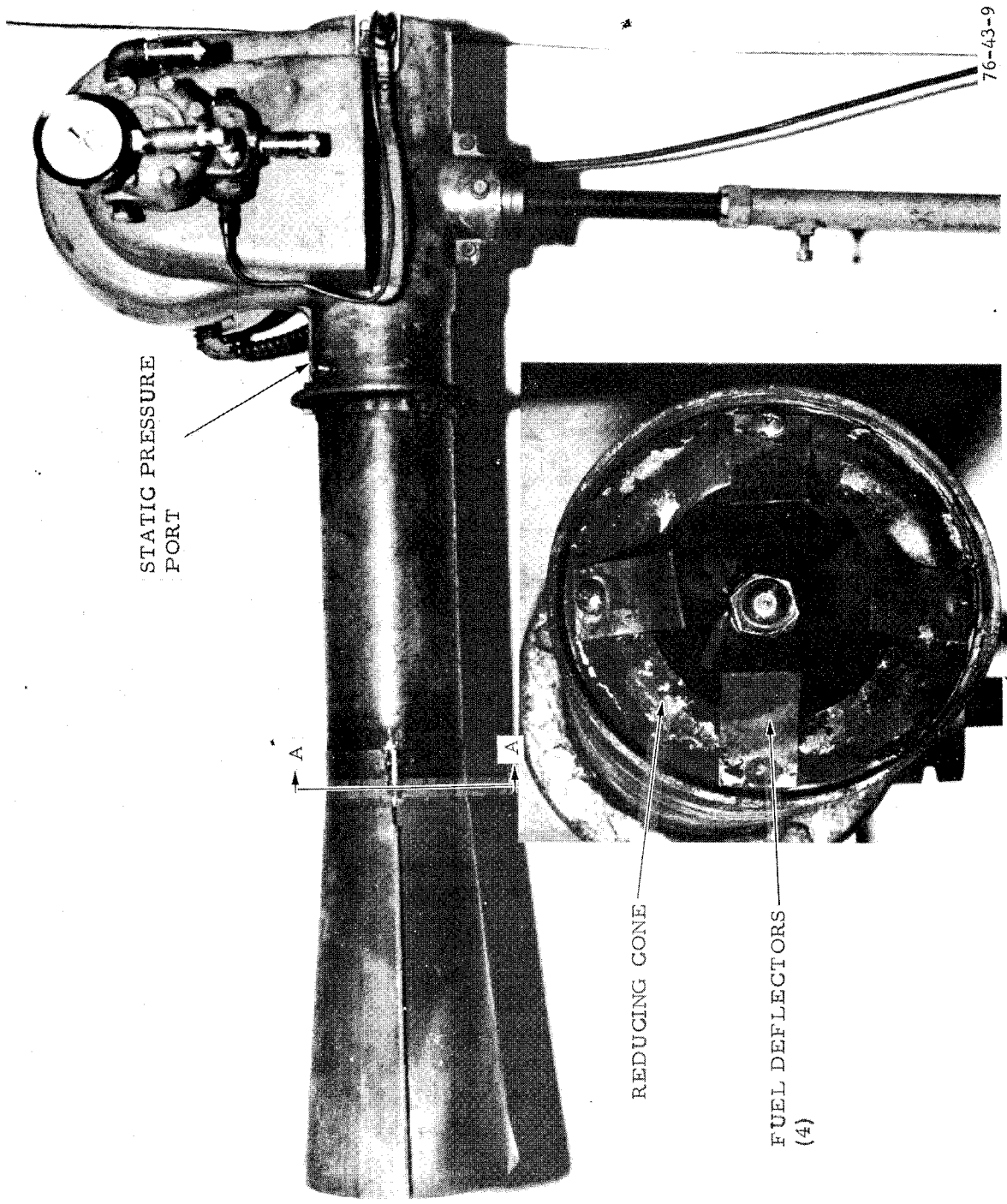

FIGURE 8. OXYGEN SENSING PROBE





STATIC PRESSURE  
PORT

A

A

REDUCING CONE

FUEL DEFLECTORS  
(4)

76-43-9

SEC. A-A

FIGURE 9. LENNOX OB-32 CONVERSION OIL BURNER

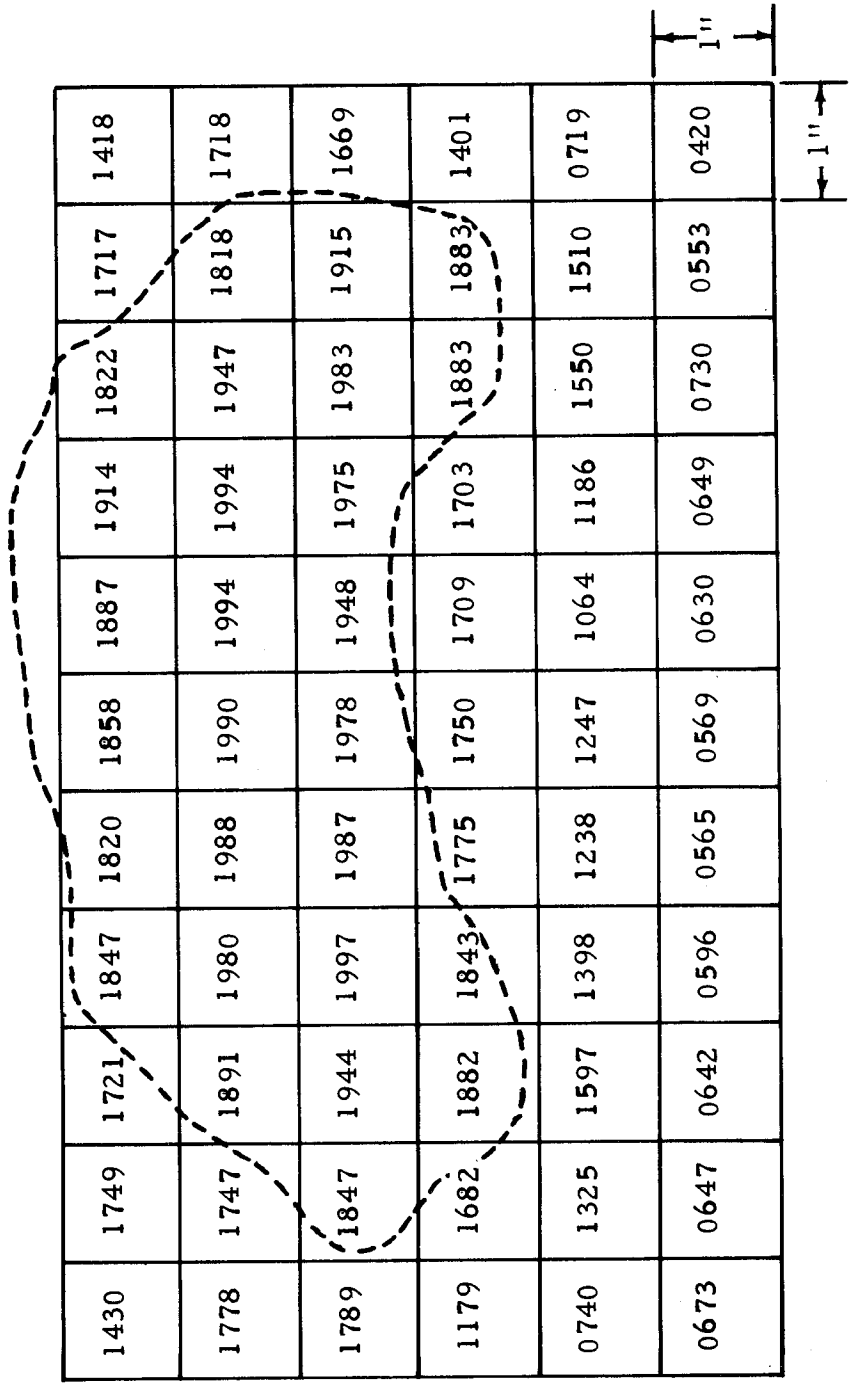

76-43-10

FIGURE 10. LENNOX OB-32 TEMPERATURE PROFILE

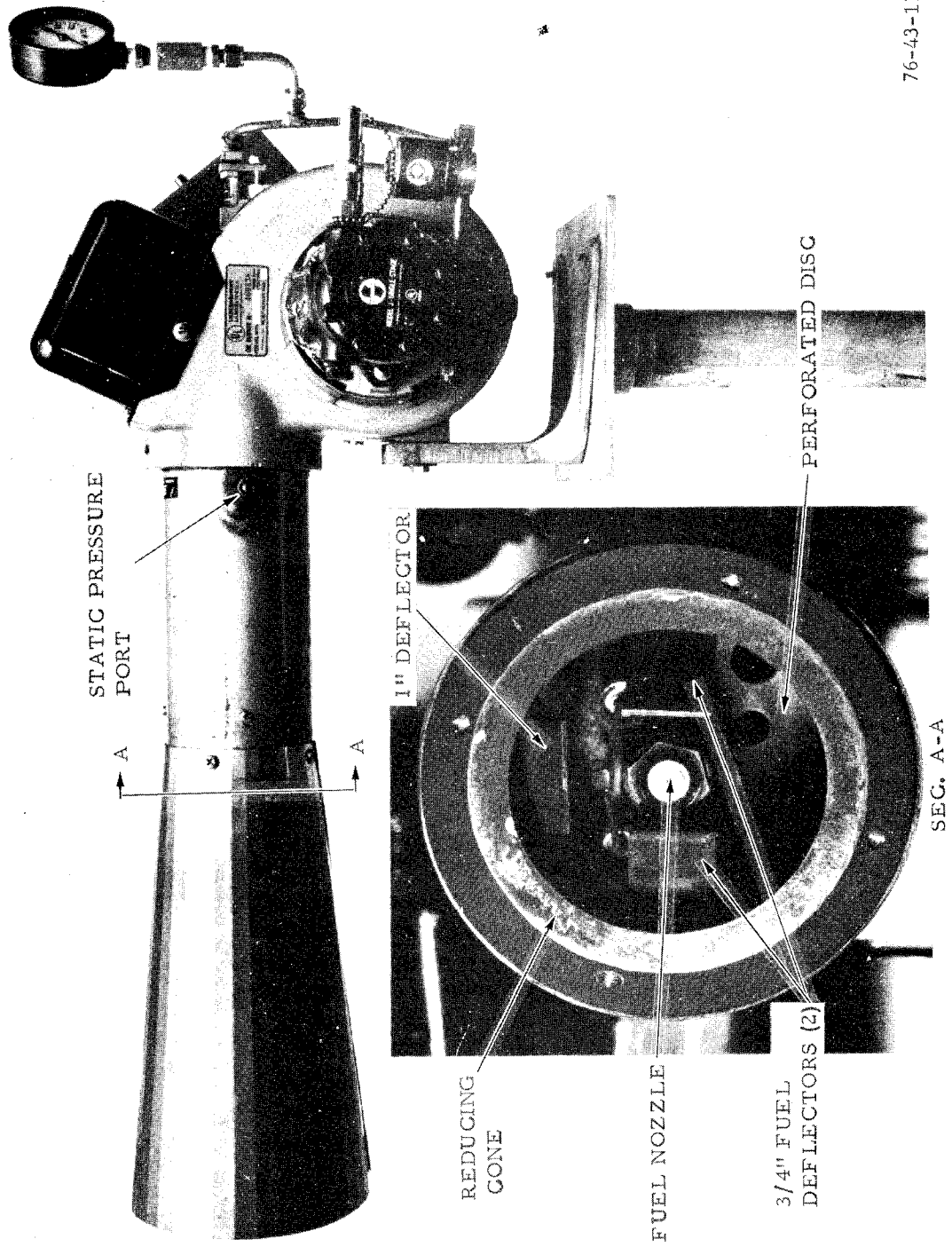

76-43-11

FIGURE 11. CARLIN 200 CRD CONVERSION OIL BURNER

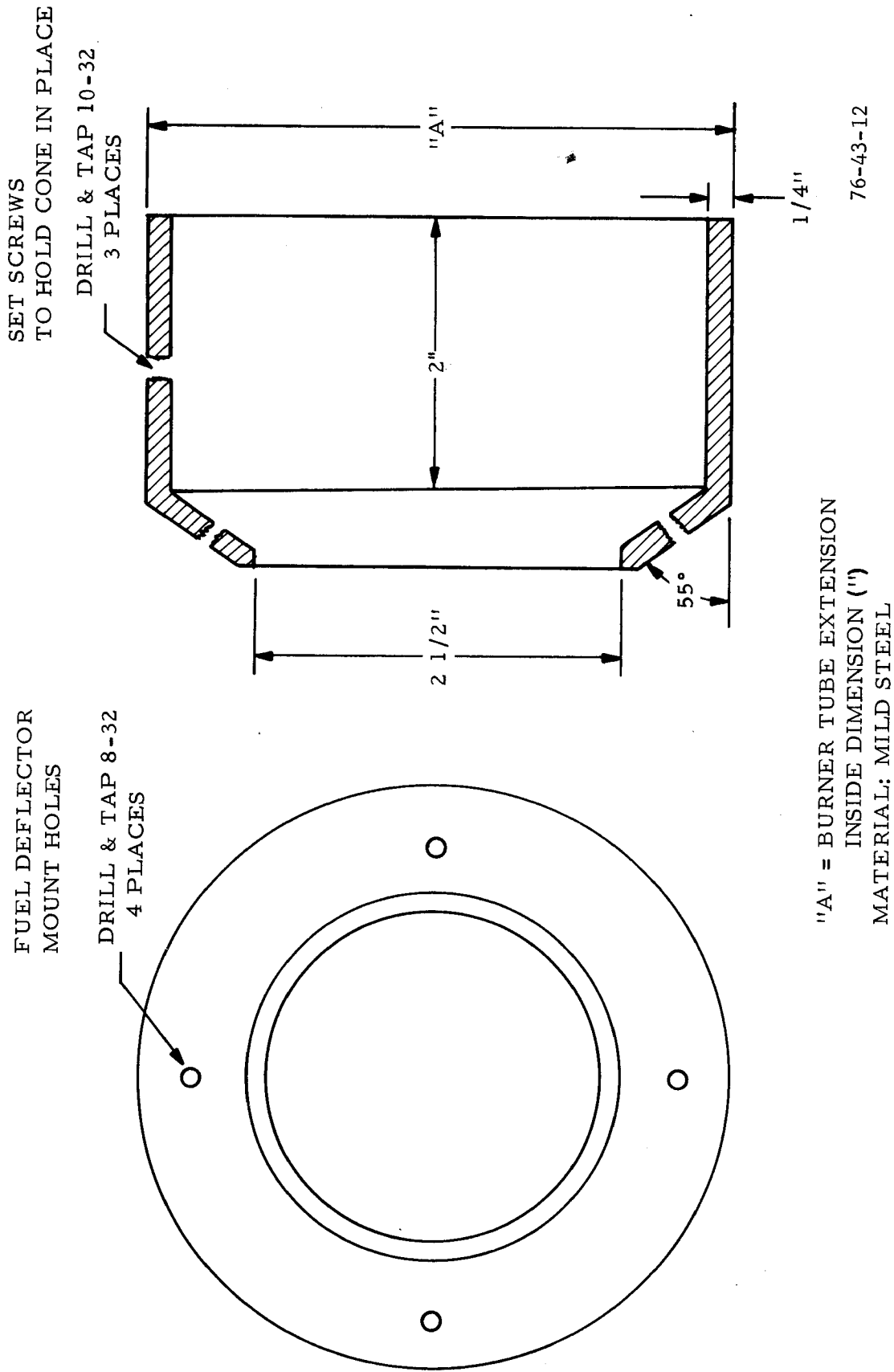

FIGURE 12. AIR TUBE REDUCING CONE

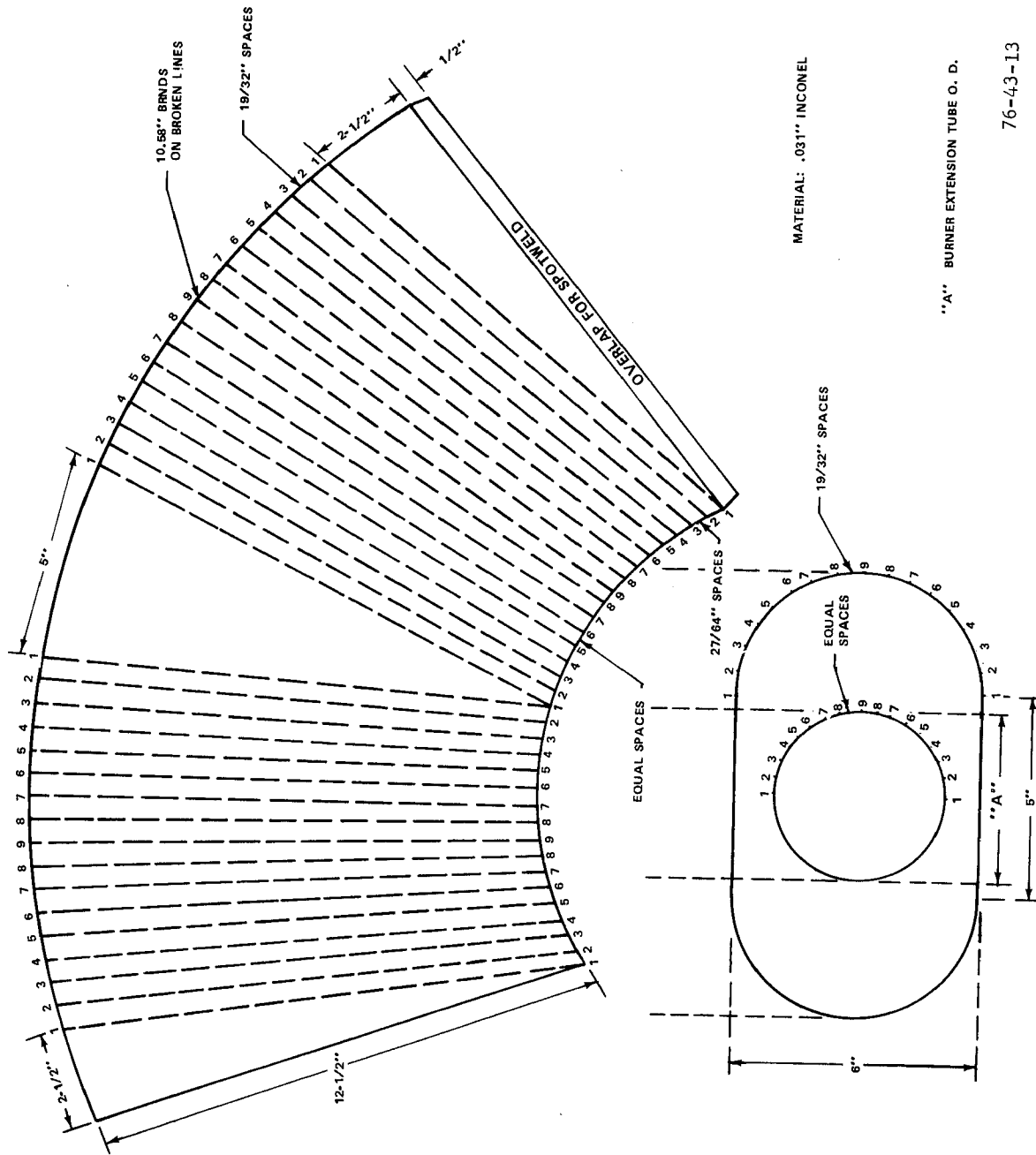
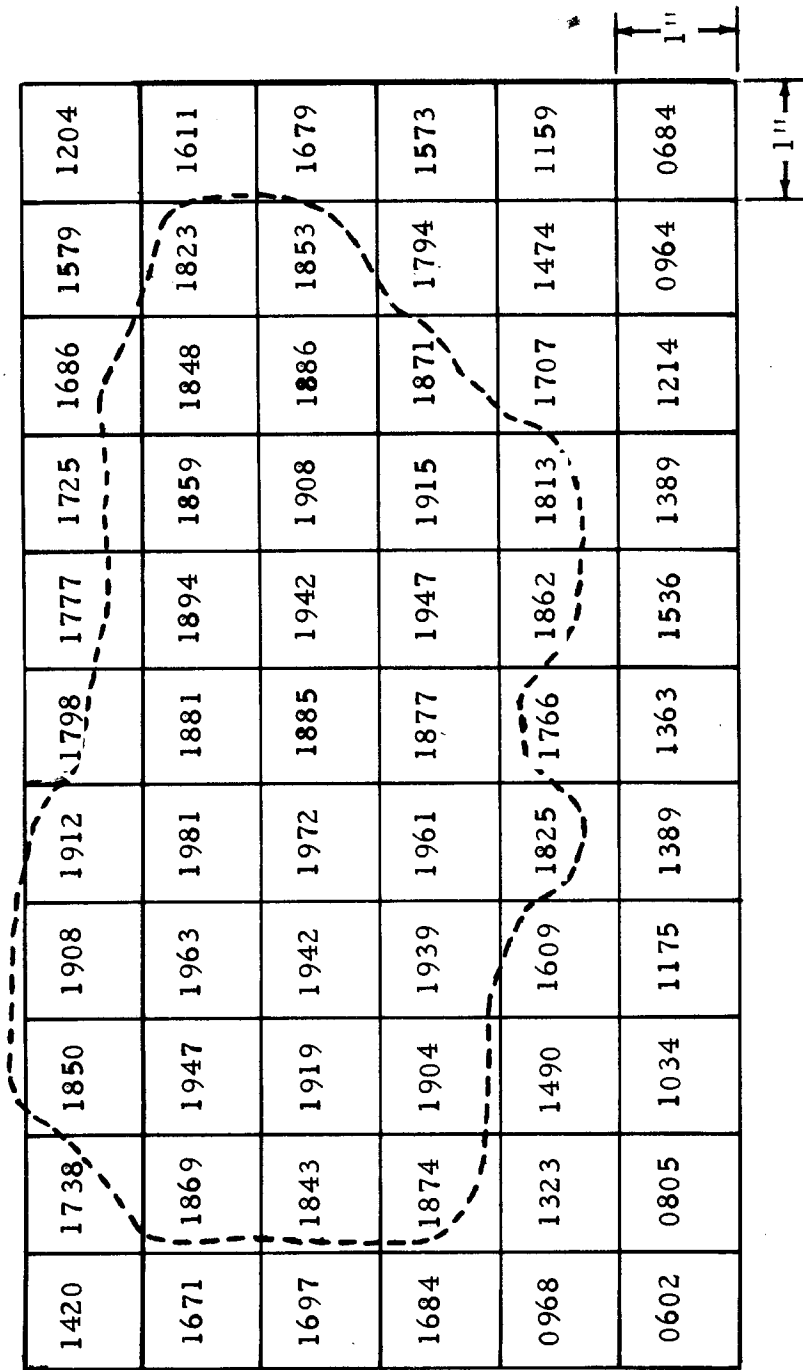

FIGURE 13. BURNER TUBE EXTENSION

76-43-13



76-43-14

----- = 1800°F

FIGURE 14. CARLIN 200 CRD TEMPERATURE PROFILE

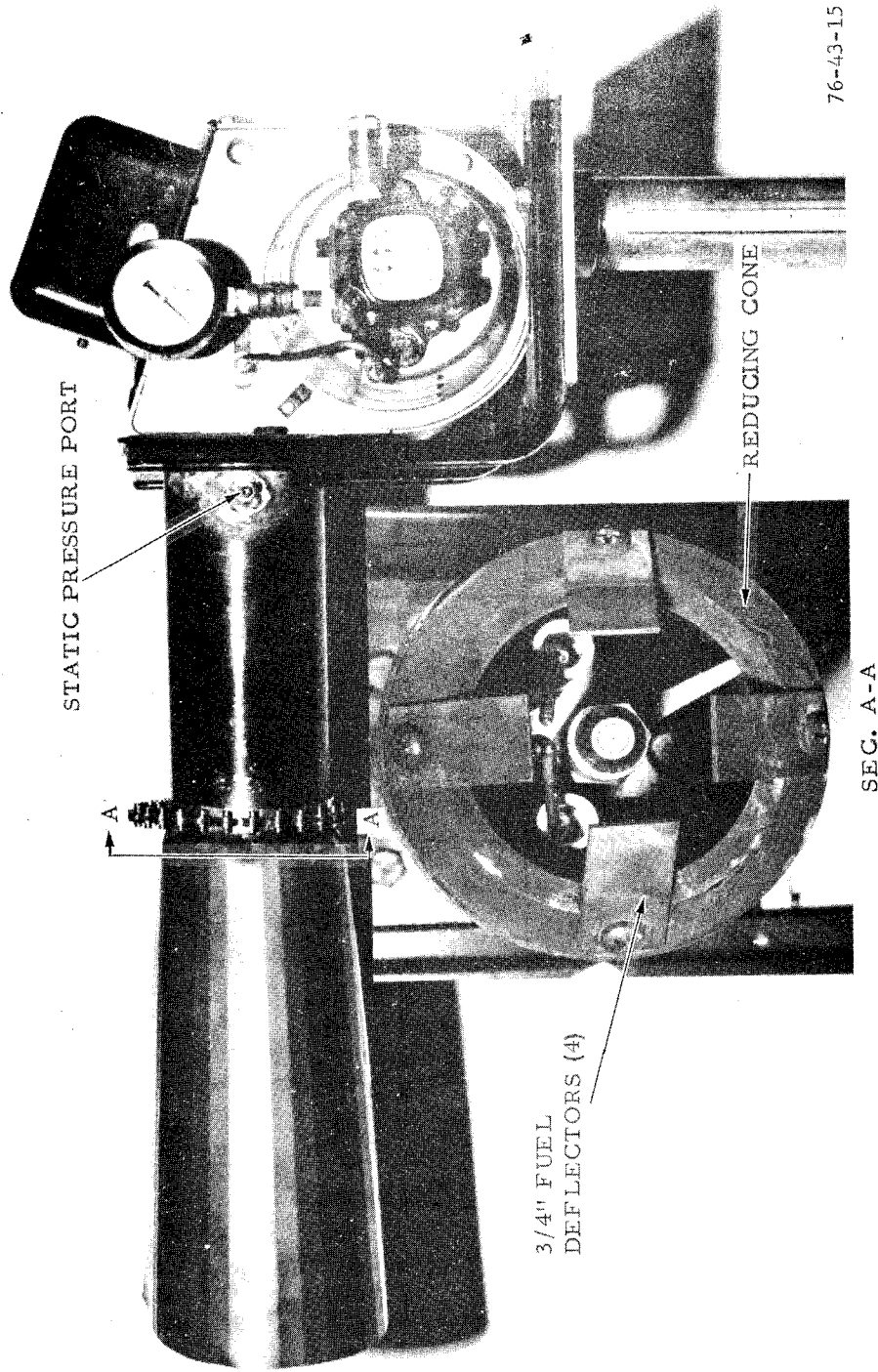

76-43-15

FIGURE 15. STEWART-WARNER HPR-250 CONVERSION OIL BURNER

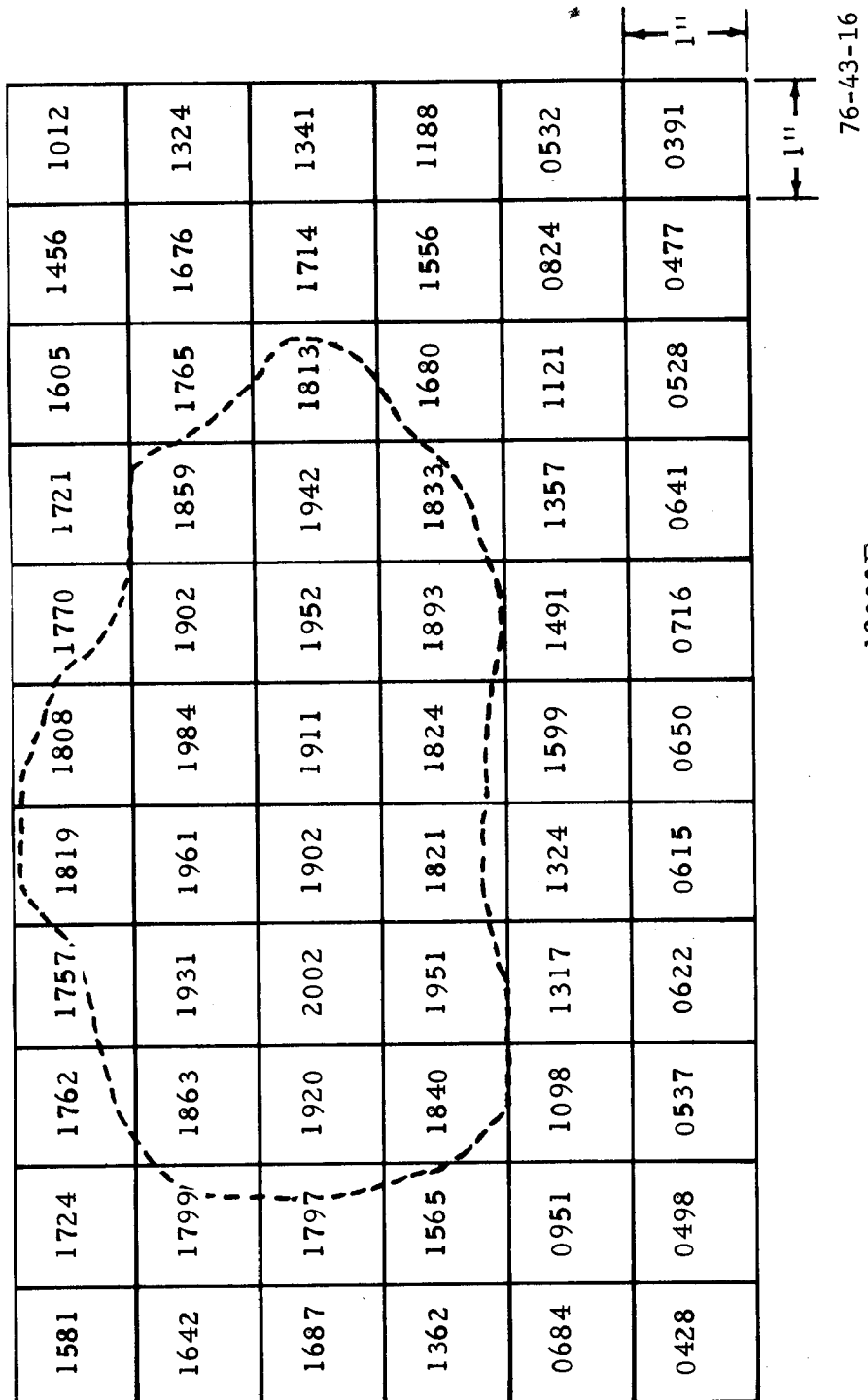
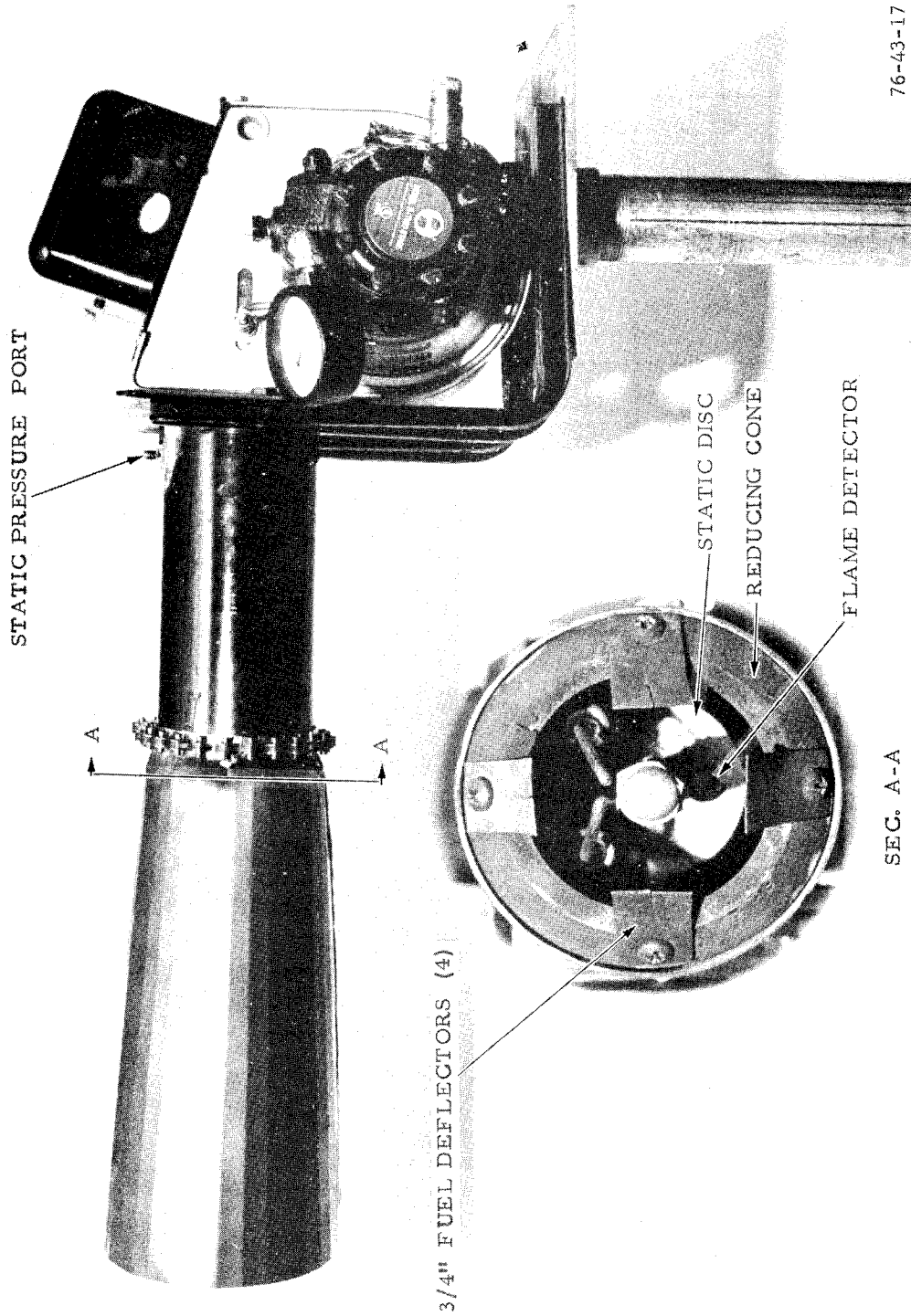

FIGURE 16. STEWART-WARNER HPR-250 TEMPERATURE PROFILE





76-43-17

FIGURE 17. STEWART-WARNER FR-600 CONVERSION OIL BURNER

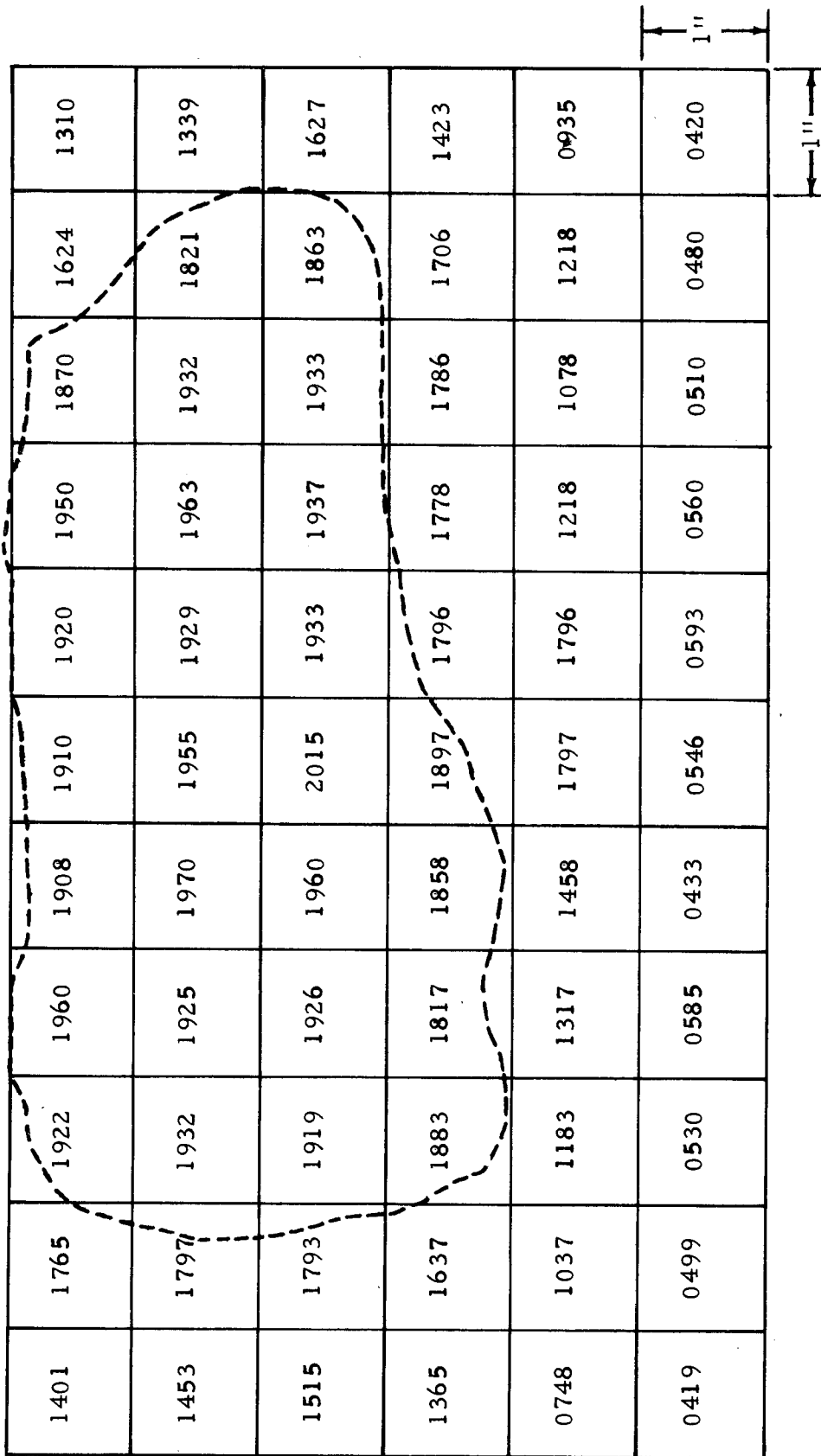

76-43-18

-----=1800°F

FIGURE 18. STEWART-WARNER FR-600 TEMPERATURE PROFILE

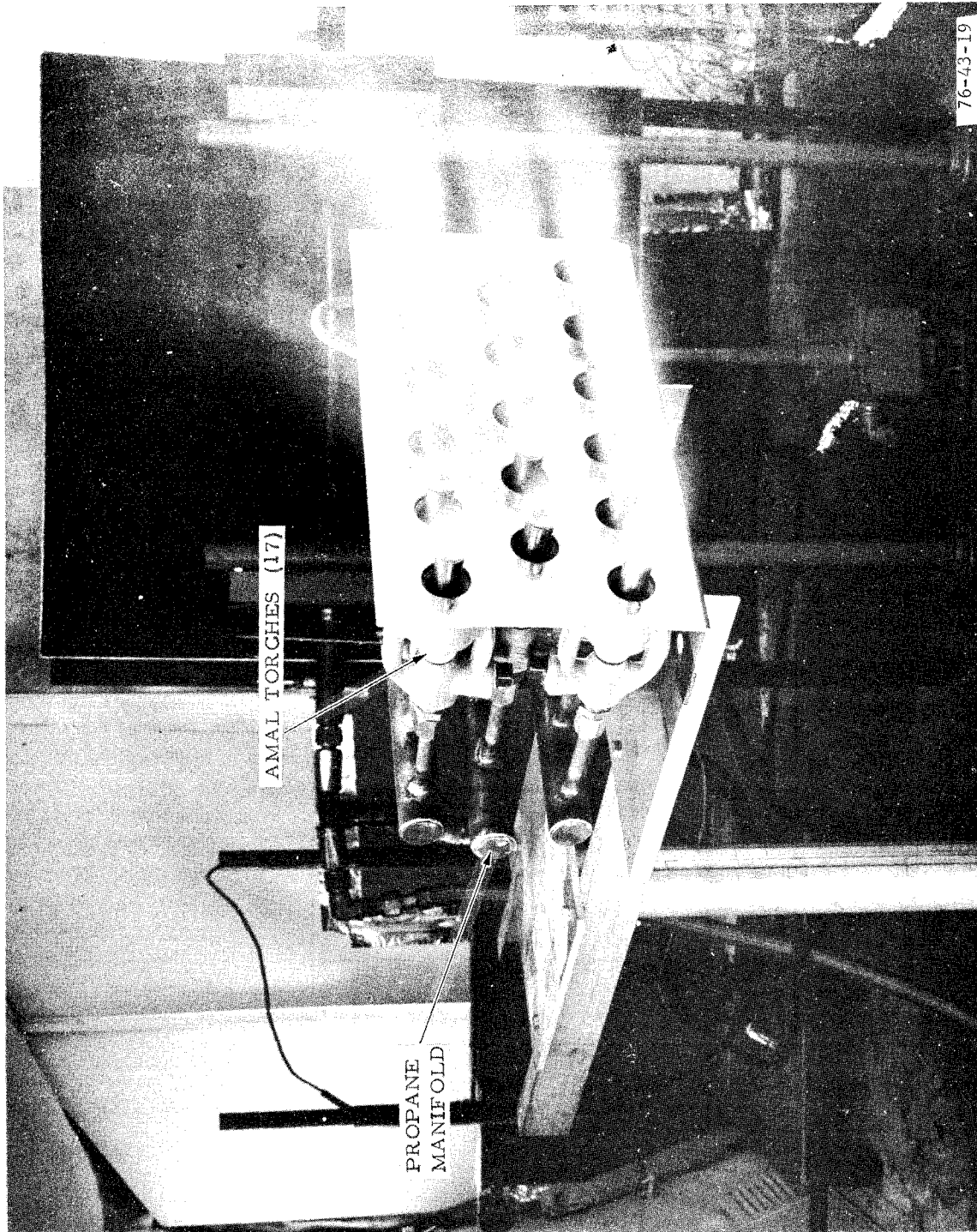

FIGURE 19. AMAL 17 TORCH ARRANGEMENT

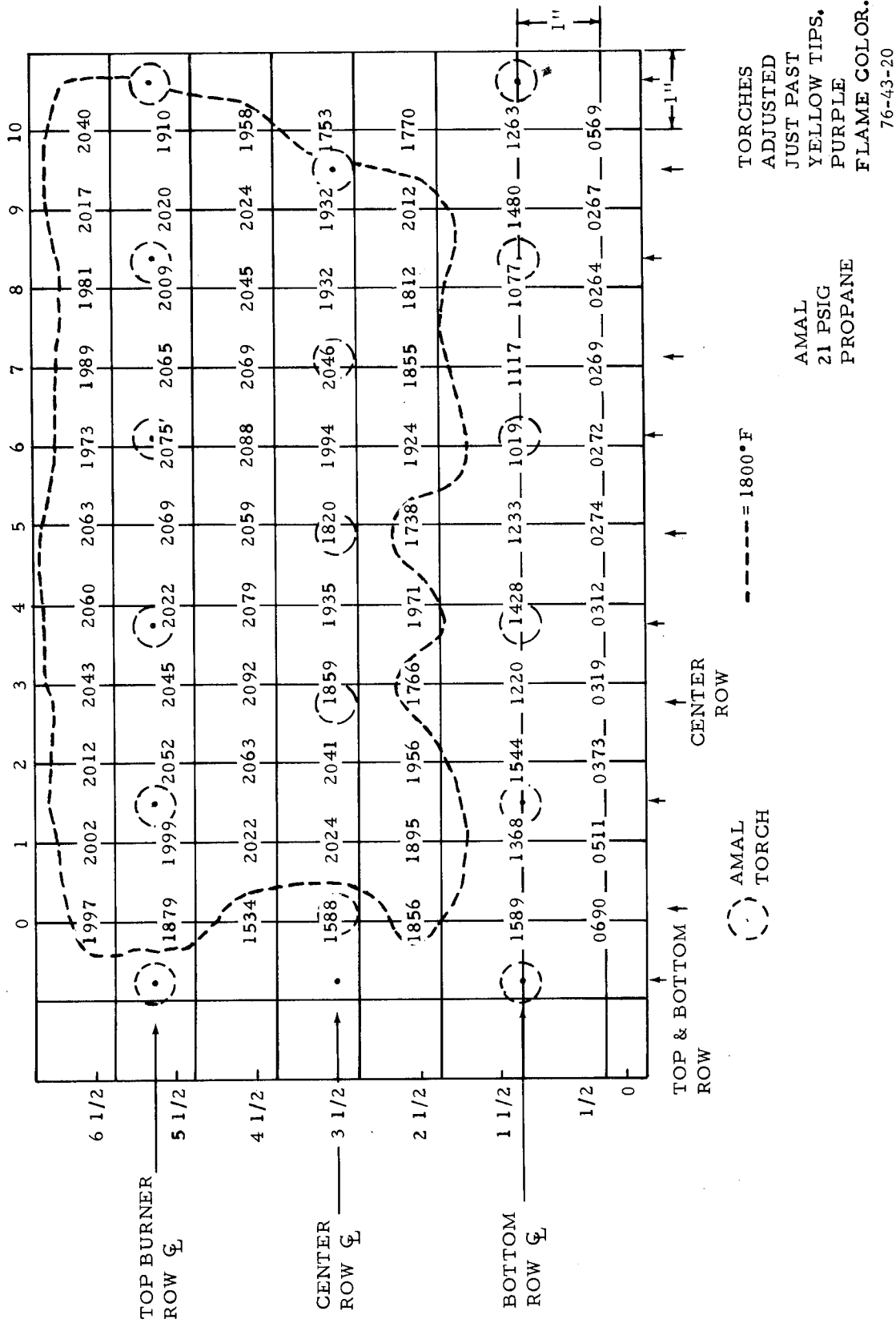

FIGURE 20. AMAL 17 TORCH TEMPERATURE PROFILE

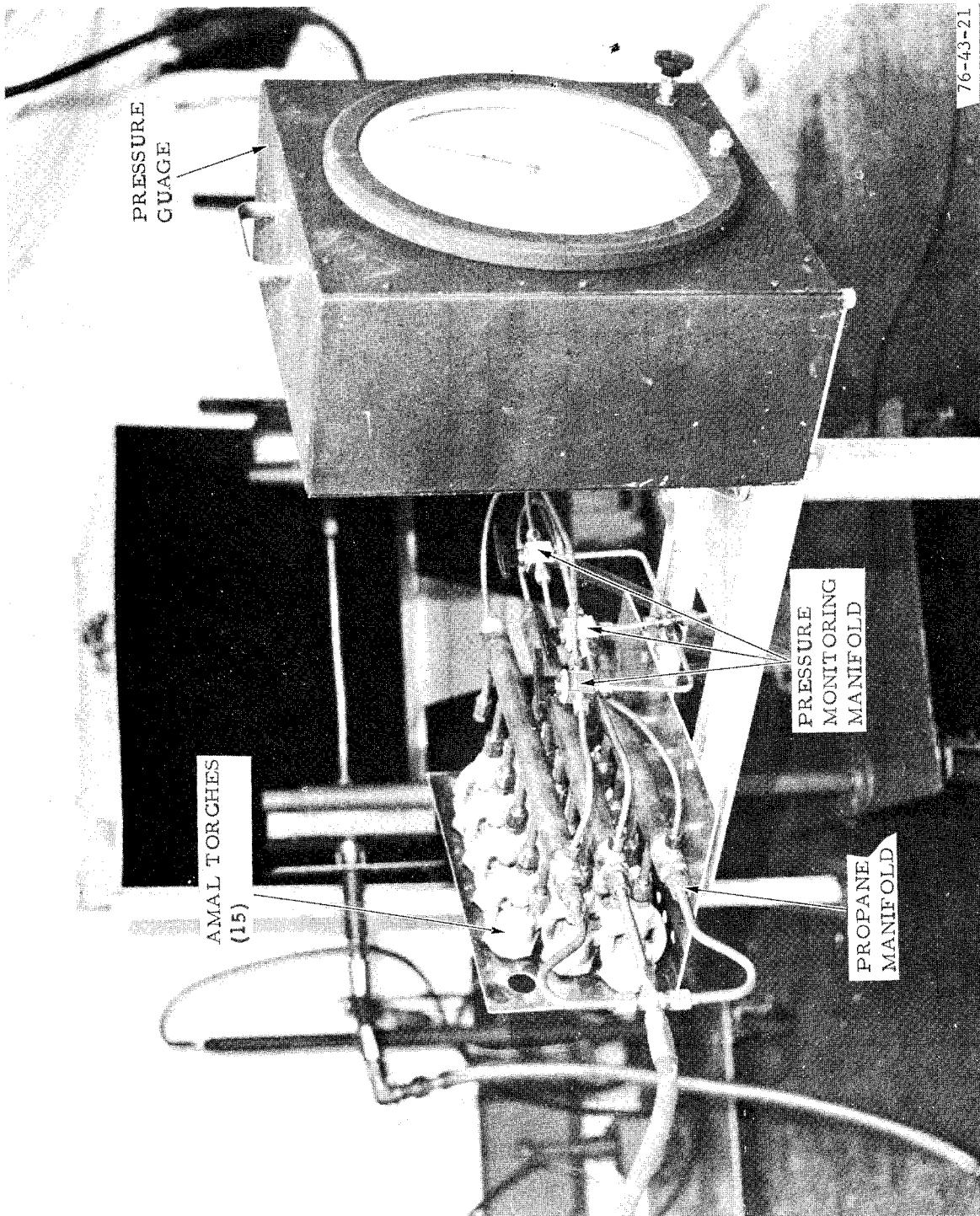

FIGURE 21. AMAL 15 TORCH ARRANGEMENT

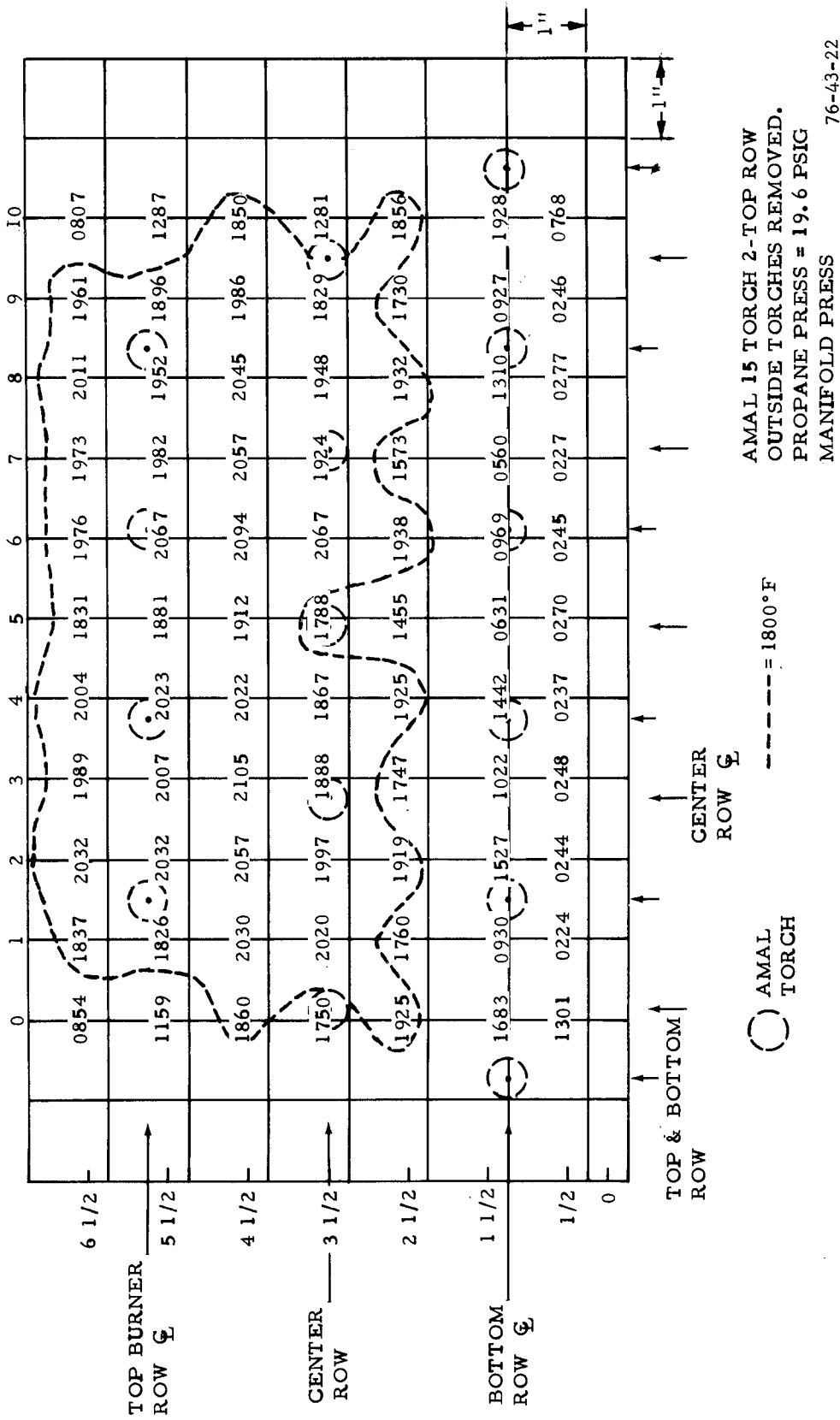

FIGURE 22. AMAL 15 TORCH TEMPERATURE PROFILE

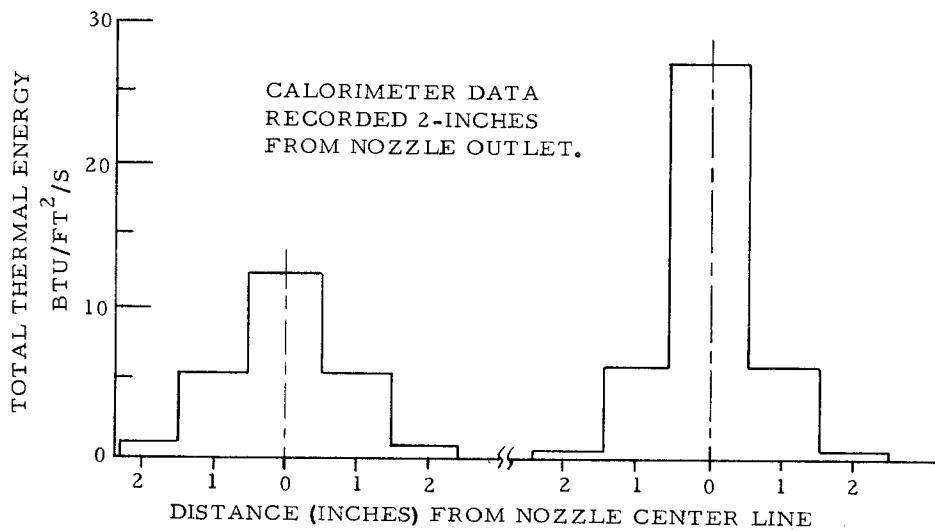
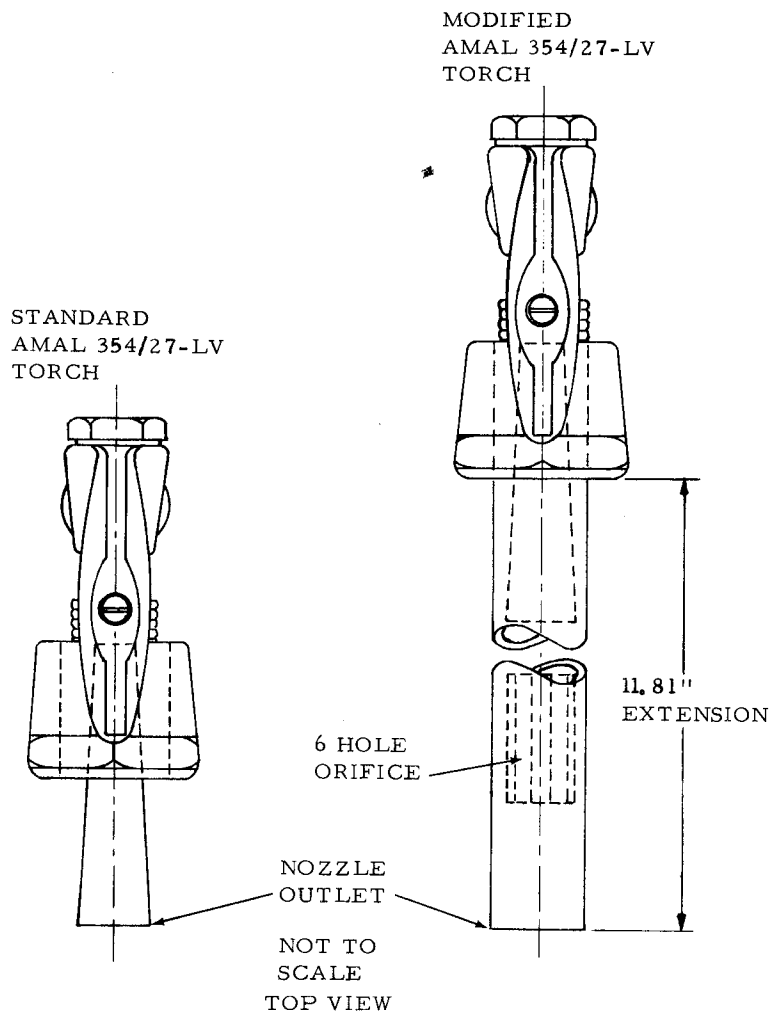

FIGURE 23. AMAL PERIPHERY Btu/ft<sup>2</sup>/s PROFILE

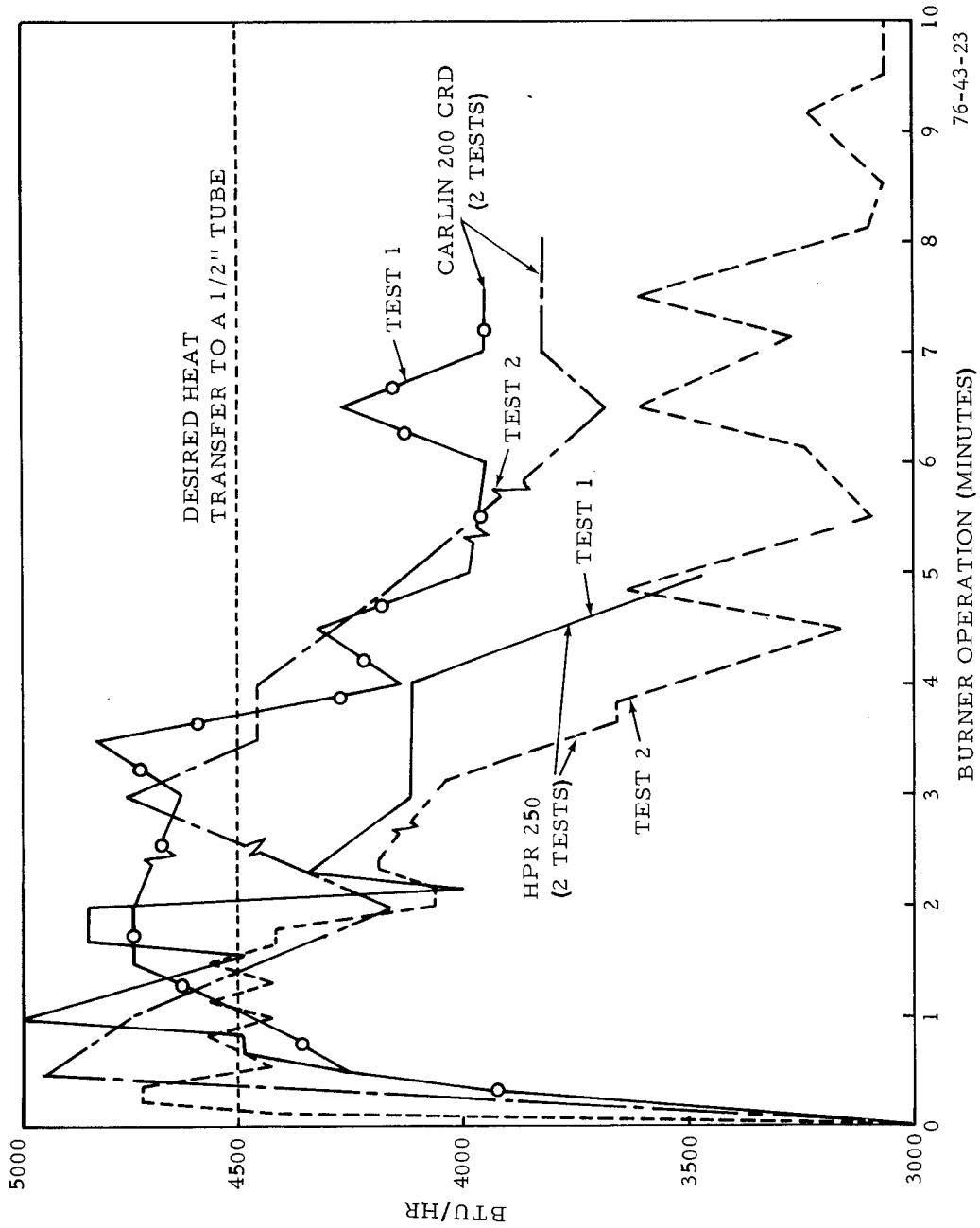

FIGURE 24. EFFECT OF SOOT AND CARBON BUILDUP ON THE 1/2 INCH HEAT TRANSFER TUBE



## APPENDIX

### EQUIPMENT SPECIFICATIONS

**Burner Standardization Apparatus:** The details and specifications are described in reference 1.

**Calorimeter:** A total heat transducer with a range of 0 to 30 Btu/ft<sup>2</sup>/s with an accuracy of +3 percent, repeatability of +0.5 percent and linearity of +2 percent. The body of the calorimeter is constructed of oxygen-free hard copper and 300 series stainless steel and is water cooled.

**Thermocouples:** Welded, grounded type with a metal sheath and tightly compacted ceramic insulation to protect the thermocouple elements. The measuring junction consists of two 30-AWG wires contained in the 1/16-inch sheath and having a response of 0.09 seconds (63.2-percent step change from room temperature to boiling water).

**Oxygen Concentration:** The process analyzer is a dual range (0 to 5 percent and 0 to 25 percent) instrument with a system accuracy of +1 percent of full scale at a given sample temperature, +6 percent of full scale for a sample temperature variation from 32° F to 110° F. The response time is rated at 90 percent full scale in 20 seconds. The flame's gas sample is routed through a room temperature water bath for temperature control and stability.

**Air Meter and Probe:** This system is capable of monitoring low-velocity air-flows with an accuracy of +2 percent with a response time of less than 1 second.

**Data Acquisition System:** A system capable of recording 2.5 channels of millivolt data per second with a low-level accuracy of +0.1 percent of reading, one digit, or 5 microvolts, whichever is greater; +1 digit. Temperature accuracy is +0.2 percent of span.

**Single Pen Servo:** A recording servo with a millivolt input range of 1 to 500 and a voltage input range from 1 to 100. The response is rated to 1/8 second full range and accuracy rated at 1/2 percent of full scale on any range. Recording paper speed ranges from 0.75 inches/hour or minute to 12-inches/hour or minute.