

FSS 000012R

SSH

6

DOT/FAA/Ct-82/42

STUDY OF HAND-HELD FIRE EXTINGUISHERS
ABOARD CIVIL AVIATION AIRCRAFT

L. M. Krasner
Factory Mutual Research Corporation
1151 Boston-Providence Turnpike
Norwood, MA 02062
Contract No. DTFA03-81-C-00029
FMRC J.I. OGON9.RG

April 1982

Final Report

Prepared for
U.S. DEPARTMENT OF TRANSPORTATION
Federal Aviation Administration
Technical Center
Atlantic City, NJ 08405

NOTICE

This document is disseminated under the sponsorship of the Department of Transportation in the interest of information exchange. The United States Government assumes no liability for the contents or use thereof.

1. Report No. DOT/FAA/CT-82/42	2.	3. Recipient's Accession No.	
4. Title and Subtitle STUDY OF HAND-HELD FIRE EXTINGUISHERS ABOARD CIVIL AVIATION AIRCRAFT		5. Report Date April 1982	
		6.	
7. Author(s) Lawrence M. Krasner		8. Performing Organization Report No. FMRC J.I. OGON9.RG	
9. Performing Organization Name and Address Factory Mutual Research Corporation 1151 Boston-Providence Turnpike Norwood, Massachusetts 02062		10. Project/Task/Work Unit No.	
		11. Contract or Grant No. DTFA03-81-C-00029	
12. Sponsoring Organization Name and Address U.S. Department of Transportation Federal Aviation Administration Technical Center Atlantic City Airport, New Jersey 08405		13. Type of Report Final Report	
		14. ACT-350	
15. Supplementary Notes			
16. Abstract A study of hand-held fire extinguishers aboard civil aviation aircraft involved a detailed survey of the past, current and potential use of hand-held extinguishers in civil aviation. A comprehensive literature search was conducted in conjunction with numerous on-site visits to a wide spectrum of users and manufacturers within the United States. Data on pertinent regulations, standards, policy, loss history, and testing were accumulated, reviewed, and analyzed. An evaluation of current practice and of the effectiveness and suitability of various hand-held extinguishers was conducted. Also included was an attempt to quantify the actual national experience of in-flight fires.			
17. Originator's Key Words Aircraft Cabin Fire Hand-held Extinguishers		18. Availability Statement Document is available to the U.S. Public through the National Technical Information Service, Springfield, Virginia 22161	
19. U. S. Security Classif. of the Report UNCLASSIFIED	20. U. S. Security Classif. of This Page UNCLASSIFIED	21. No. of Pages	22. Price

METRIC CONVERSION FACTORS

Approximate Conversions to Metric Measures

Symbol	When You Know	Multiply by	To Find	Symbol
LENGTH				
in	inches	*2.5	centimeters	cm
ft	feet	30	centimeters	cm
yd	yards	0.9	meters	m
mi	miles	1.6	kilometers	km
AREA				
in ²	square inches	6.5	square centimeters	cm ²
ft ²	square feet	0.09	square meters	m ²
yd ²	square yards	0.8	square meters	m ²
mi ²	square miles	2.6	square kilometers	km ²
	acres	0.4	hectares	ha
MASS (weight)				
oz	ounces	28	grams	g
lb	pounds	0.45	kilograms	kg
	short tons (2000 lb)	0.9	tonnes	t
VOLUME				
teaspoon	teaspoons	5	milliliters	ml
fl oz	fluid ounces	15	milliliters	ml
c	cups	30	milliliters	ml
pt	pints	0.24	liters	l
qt	quarts	0.47	liters	l
gal	gallons	0.95	liters	l
ft ³	cubic feet	3.8	liters	l
yd ³	cubic yards	0.03	cubic meters	m ³
		0.76	cubic meters	m ³
TEMPERATURE (exact)				
*F	Fahrenheit temperature	5/9 (after subtracting 32)	Celsius temperature	*C

Approximate Conversions from Metric Measures

Symbol	When You Know	Multiply by	To Find	Symbol
LENGTH				
mm	millimeters	0.04	inches	in
cm	centimeters	0.4	inches	in
m	meters	3.3	feet	ft
m	meters	1.1	yards	yd
km	kilometers	0.6	miles	mi
AREA				
cm ²	square centimeters	0.16	square inches	in ²
m ²	square meters	1.2	square yards	yd ²
km ²	square kilometers	0.4	square miles	mi ²
ha	hectares (10,000 m ²)	2.5	acres	
MASS (weight)				
g	grams	0.035	ounces	oz
kg	kilograms	2.2	pounds	lb
t	tonnes (1000 kg)	1.1	short tons	
VOLUME				
ml	milliliters	0.03	fluid ounces	fl oz
l	liters	2.1	pints	pt
l	liters	1.06	quarts	qt
l	liters	0.26	gallons	gal
m ³	cubic meters	35	cubic feet	ft ³
m ³	cubic meters	1.3	cubic yards	yd ³
TEMPERATURE (exact)				
*C	Celsius temperature	9/5 (then add 32)	Fahrenheit temperature	*F

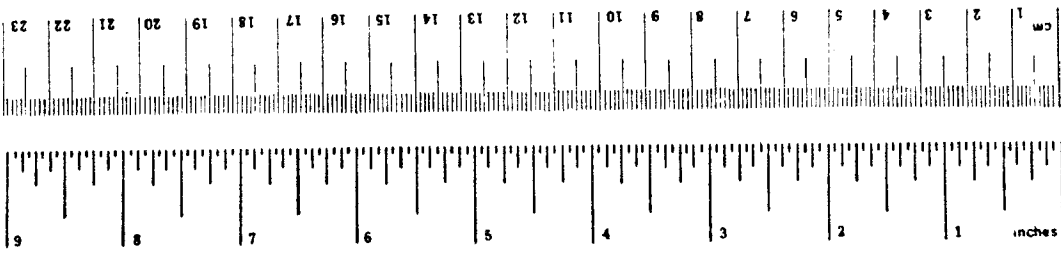

*1 m = 2.54 (exactly). For other exact conversions and more detailed tables, see NBS Misc. Publ. 286, Units of Weights and Measures, Price \$2.25, SD Catalog No. C13.10.286.

ACKNOWLEDGMENT

The author wishes to express his gratitude and appreciation to Mr. Joseph L. Buckley of FMRC for his significant contribution in the conduct of this program.

TABLE OF CONTENTS

	Page
EXECUTIVE SUMMARY	viii
INTRODUCTION	1
Background	1
Program Objectives	2
INFORMATION SOURCES	2
Literature Search	2
Visits And Personal Contacts	3
RECENT EXTINGUISHER SELECTION HISTORY IN CIVIL AVIATION	4
Commercial Aviation	4
General Aviation	9
RECENT FIRE INCIDENT HISTORY	10
TOXICITY OF PYROLYZED CABIN INTERIOR MATERIALS	21
AGENTS AND EXTINGUISHERS	22
Suppression Capability Tests	22
Agent And Extinguisher Characteristics	24
Dissipation Of Halon Concentration	34
Toxicity Of Halons	42
Summary	51
MISCELLANEOUS	52
Training	52
Environmental Testing	55
New Extinguishers	58
Extinguisher Hose/Wand	61
Smoke Goggles For General Aviation Aircraft	61
REFERENCES	62
BIBLIOGRAPHY	65

LIST OF ILLUSTRATIONS

Figure		Page
1	Extinguisher Provisions Boeing-727	5
2	Extinguisher Provisions Boeing-737	6
3	Extinguisher Provisions Boeing-747	7
4	Extinguisher Provisions Boeing-747 As Equipped By One Airline	8
5	NTSB Data Base Definitions	11
6	Service Difficulty Report(SDR), FAA Form 8070-1	12
7	Basic Fire Types and Extinguisher Ratings	25
8	Extinguisher Discharge - Cockpit Area	37
9	'BCF' Concentrations - Lorry Cab, Runs 1 And 2	39
10	Agent Concentration In Small Volume Using 1-Quart Extinguishers	40
11	Agent Concentration In Large Volume Using 1-Gallon Extinguishers	41
12	Comparison Of Relative Extinguisher Operator Performance	53
13	Memorandum To Flight Attendants	56
14	Emergency Fire Procedures For Cessna Model 152	57
15	High Expansion Foam Extinguisher	59
16	3M/Amerex Solid AFFF Extinguisher	60

LIST OF TABLES

Table		Page
1	"Larger Aircraft" Incidents	14
2	"Smaller Aircraft" Incidents	15
3	All Incidents Involving Hand-Held Extinguisher Use	16
4	"Larger Aircraft" Incidents By Location	17
5	"Smaller Aircraft" Incidents By Location	18
6	All Aircraft Incidents By Location	19
7	Comparison Data From Lockheed Report	20
8	Flammable Liquid Fire Test, Pan Size, Materials, And Arrangement	27
9	Physical Properties Of Halon 1301	29
10	Physical Properties Of Halon 1211	31
11	Extinguishing Agent Basic Characteristics	33
12	Comparative Extinguisher Costs	35
13	Decomposition Products Of Halon 1301	47
14	Decomposition Products Of Halon 1211	48
15	Data Summary - Phase II: Pyrolysis Data	50

EXECUTIVE SUMMARY

A study of hand-held fire extinguishers aboard civil aviation aircraft was initiated in February 1981 and involved a detailed survey of the past, current and potential use of hand-held extinguishers in civil aviation. A comprehensive literature search was conducted in conjunction with numerous on-site visits to a wide spectrum of users and manufacturers within the United States, including: approving and regulatory groups (including several Federal Aviation Administration (FAA) regional offices); manufacturers of agents and extinguishers; concerned organizations such as the Airline Pilots Association (ALPA) and the Air Transport Association (ATA); large and small airframe manufacturers; and numerous aircraft operators. Also included was an attempt to quantify the actual national experience of in-flight fires.

When the guidelines for this program were being developed by the sponsor, the basic final objective was that the study provide information sufficient to furnish definitive guidance to the ultimate users. During this development, the subject of hand-held extinguishers for civil aviation independently became very active; in August 1980 a new FAA advisory circular (20-42A) was issued entitled "Hand Fire Extinguishers for Use in Aircraft." At approximately the same time, the first of a series of so-called volatile liquid hijackings took place. The advisory circular indicated acceptability of hand fire extinguishers having an Underwriters' Laboratories (UL) toxicity rating of five (5) or higher for use in occupied areas and, for the first time, allowed for the use of Halon 1211. These hijackings led to FAA Office of Civil Aviation Security involvement, resulting in a series of tests at the FAA Technical Center in Atlantic City during which various types of hand-held extinguishers were used on aircraft seats which had been doused with a volatile liquid and ignited. The net result of this series of tests was a general notice (November 28, 1980) which encouraged certificate holders "to either replace some of their existing fire extinguishers with at least two Halon 1211 extinguishers, or add at least two Halon 1211 extinguishers to those required by Federal Aviation Regulation (FAR) 121.309(C)." It must be recognized that these activities ultimately had a strong impact on the direction and emphasis of this study.

During the conduct of on-site visits it became clear that the carriers were currently using water extinguishers and CO₂ or water extinguishers and dry chemical, CO₂ being used in the majority of cases. Some carriers had intentions of following the general notice recommendation; some did not; and some were undecided. Those carriers indicating an intention to use Halon 1211 planned to retrofit their entire fleets, i.e., to replace all existing CO₂ protection in passenger compartments with Halon 1211. This decision was apparently made for purposes of standardization resulting in obvious advantages to training and maintenance. Those carriers resisting or undecided indicated that there were unanswered agent toxicity issues and/or that the Technical Center tests were not representative. The only other live fire tests of which the author is aware on simulated aircraft passenger compartment scenarios using Halon 1211 and other types of extinguishers in comparison were conducted by Boeing and by American Airlines. Boeing would not release their test data but the author was made to understand that the several scenarios were Class A fires. It was on the basis of these data that Boeing made a commitment to the use of Halon 1211. American Airlines conducted tests on volatile liquid-soaked aircraft carpeting, seat covers, and cushions. These tests showed no significant difference between Halon 1211 and CO₂. It should be noted that a 5BC rated Halon 1211 extinguisher has a significant weight advantage over a comparably rated CO₂ extinguisher.

It also became clear during the conduct of on-site visits that the readily accessible data bases accumulating information on aircraft cabin fires (cockpit, passenger, cargo) were less than perfect. The largest pertinent data base (in terms of number of incidents) results from Service Difficulty Reports (SDR) and is maintained by the FAA Aeronautical Center in Oklahoma City. This data base has been computerized since January 1976. However, little narrative is associated with these records. In addition to the SDR data base, the FAA maintains an Accident Incident Data System (AIDS) and one major carrier admits to having a computerized base from which fire incidents may be extracted. Several other carriers maintain manual files of fire incidents. Fragmented or isolated reports may also exist in more narrative detail in organizations such as the Association of Flight Attendants. The major airframe manufacturers also maintain manual files relating to fire for various aircraft. From all sources it is clear that even the SDR data base does not represent 100 percent of the in-cabin smoke and fire incidents actually occurring due to non-reporting, miscoding, and probably many other reasons. Exactly what percent of the population is represented is impossible to determine. For reference, however, one carrier apparently has three to four times the pertinent incidents recorded (January 1, 1979-March 26, 1981) on their computerized data base as does the SDR base. Again, for a reference point, the SDR base included 321 relevant incidents (January 1, 1976-April 8, 1981), an average of 62 per year. Of these incidents 238 occurred in the DC-9 size class and up. Of those 238 incident reports 18 (7.6 percent) stated that smoking materials were involved; 156 (65.5 percent) were classified as electrical in nature; 29 (12.2 percent) stated that a hand-held extinguisher was used; 168 (70.6 percent) involved galleys; and 22 (9.2 percent) involved lavatories.

One further observation, quite clear after visiting major carriers, was a lack of consistency in flight crew training. The Federal Aviation Regulation (121.417(C)) requires that each crew member must operate each type of fire extinguisher during initial training and once during each 24 calendar months. The FAR does not, in fact, require the fighting of an actual fire (standardized, representative, or otherwise) nor, for that matter, the actual discharge of extinguishing agent. Therein lies the lack of uniformity in the field.

It appears that, if the environment is examined logically with respect to extinguisher selection, it is possible to define four subsets: DC-9 size class and up passenger compartments; flight stations/cockpits of that size class plane; small (2-6 seats) general aviation aircraft; and intermediate-size aircraft. In terms of interior volume and mental alertness requirements, there is justification for considering cockpits and small general aviation aircraft analogous. In terms of air movement and breathing apparatus they are not equivalent. The large aircraft passenger compartments differ from cockpits because of their large volumes. In addition, potential effects of judgment impairment are not as critical. Further, ventilation (one air change per every 3 minutes) is generally a normal condition. The intermediate-size aircraft should be treated, in essence, on individual bases, sometimes falling under the recommendations for the smaller volume, sometimes under the recommendations for the larger volume, depending on exact volume, fire loads, ventilation, etc.

In considering the small-volume aircraft, the advantages (range and directionality) attributed to Halon 1211 over Halon 1301 from previous Air Force studies are not appropriate, as they are for large aircraft passenger compartments. It is therefore conceivable that a neat state margin of safety of Halon 1301 over Halon 1211 would be worth exploiting in small volumes. It should be noted that as of this report there is not a single Factory Mutual-Approved or Underwriters' Laboratories

listed Halon 1301 hand-held fire extinguisher in the 2 1/2 - 3-pound range. However, one manufacturer is attempting to obtain an approval.

In considering the flight deck of the large volume pressurized aircraft, the advantages of breathing apparatus, good low level air discharge (Halons are heavier than air) resulting in rapid dissipation, and the remote threat of other than an electrical fire would make a choice of Halon 1211 over Halon 1301 acceptable if desired.

In considering the large volume passenger compartments it must be recognized that potential fire scenarios fall into two broad groups. The first is the high-frequency, low-severity fires. The other is the low-frequency, high severity "rare" or potential situation such as would result from a volatile liquid-soaked passenger seat ignition. Halon 1211 has clearly been shown to provide superior fire fighting capability for such a scenario. The toxicity of Halon 1211 also has two distinct issues: the neat state (undecomposed), and the decomposed state. The neat state issue is in essence one of acceptable concentration (percent by volume) levels for human exposure over a nominal 3-5 minute time interval. The results of inhalation toxicity work combined with data on ventilation and dissipation rates are all pertinent in the decision-making process. It is the belief of the author that enough information exists to indicate that neat state toxicity of Halon 1211 should not be considered a problem in large-volume passenger compartments. Halon 1211 decomposes when exposed to flame or hot surfaces in the vicinity of 900°F. It is fairly well agreed that definitive concentration limits are not accurately known for short-term human exposure to the products of decomposition. However, when addressing the decomposed-state toxicity, it is necessary to put the hazard into proper perspective. To do so, the two general fire scenarios discussed previously should be considered individually.

For the "small" fire scenario it is likely that the fire will be extinguished rapidly with little agent decomposition. For the "large" fire scenario, agent decomposition is expected. However, until recently, accurate expected decomposition product concentrations for this scenario in a representative environment were also not known. Tests recently completed at the FAA Technical Center produced measured levels of Halon 1211 decomposition products significantly below the best available human tolerance limits. It should further be recognized that burning aircraft interior materials (seats, carpet, wall laminates, etc.) will, by themselves, generate toxic gases as products of combustion in addition to smoke and heat. Thus, the priority must be to extinguish the fire as rapidly as possible. Whatever increased capability Halon 1211 provides toward that end should, therefore, be exploited.

In view of incident history, the total number of hand-held extinguishers currently manufacturer-provided for air carriers (5-8 depending on aircraft size) appears adequate. However, the fire-fighting capabilities of Halon 1211 (throw range, penetration into voids and gaps, and control of the placement of the discharge stream) make it a better agent for large aircraft than either CO₂ or dry chemical. Nevertheless, at least some water extinguishers should be retained as a securing agent due to the capability of water for cooling and for the deep-seated smoldering fire. The water should be available for application subsequent to the Halon 1211 application. It should be noted that coffee, soda and other readily available non-alcoholic beverages can also be effective for such application.

INTRODUCTION

BACKGROUND.

United States Federal Aviation Regulation (FAR) Part 121, Certification and Operation for Domestic, Flag and Supplemental Air Carriers, and Commercial Operation of Large Aircraft, provides for hand-held fire extinguishers in crew, passenger and cargo compartments. The regulation states that "the type and quantity of extinguishing agent must be suitable for the kinds of fires likely to occur in the compartment where the extinguisher is intended to be used" with a minimum of one extinguisher for the flight deck and one additional extinguisher for the passenger compartment of each aircraft accommodating 7-30 passengers or two additional extinguishers when greater than 30 passengers may be accommodated. FAR Part 91 - General Operating and Flight Rules has identical requirements for large and turbine-powered, multi-engined airplanes. FAR Part 135 for Air Taxi and Commercial Operation is different only in that one hand-held extinguisher in addition to the flight deck requirement is required for passenger compartments of aircraft having a passenger seating configuration of 10-30 seats. FAR Part 23 for General Aviation has no requirements. In addition to the FAR's, other related guidance provided by the Federal Aviation Administration (FAA) appears in Advisory Circular (AC) 20-42A "Hand Fire Extinguishers For Use in Aircraft." In early 1980, this advisory circular (originally 20-42) dated back to 1965 and clearly did not reflect the state-of-the-art in hand-held fire extinguishers. These facts were recognized in 1980 by the FAA and ultimately resulted in funding for the present effort.

As wheels were set in motion for the funding of this effort, two events took place which would ultimately impact on the direction and emphasis of the study:

1. The revision of Advisory Circular AC 20-42, dated 7/29/80, which allowed for the use in occupied spaces of any hand fire extinguisher having a toxicity rating of five or higher. Included in this group are two halogenated hydrocarbon agents, Halon 1301 and Halon 1211. These agents were not mentioned in the superseded version of 20-42A. It should be noted that, since the funding of this effort, AC 20-42A was again revised as a draft 20-42B. As of this writing, 20-42B has not as yet been issued.
2. The first of a series of so-called volatile liquid hijackings which began at approximately the same time as the issuance of the revised AC 20-42A. In these incidents, a hijacker carried on board a quantity of volatile liquid and threatened to pour and ignite that liquid. These incidents represented a potential fire scenario which previously had not been experienced. The immediate question was whether existing capability would handle such a scenario. At that time, the FAA Office of Civil Aviation Security became involved and sponsored a series of tests at the FAA Technical Center in Atlantic City during which various types of hand-held extinguishers were used on aircraft seats which had been doused with a volatile liquid and ignited. These tests clearly indicated that, of the extinguishing agents used, Halon 1211 had superior fire fighting capabilities for that fire scenario. The net result of this series of tests was a general notice (November 28, 1980) which encouraged certificate holders "to either replace some of their existing fire extinguishers with at least two Halon 1211 extinguishers, or add at least two Halon 1211 extinguishers to those required by FAR 121.309(C)."

The reaction from the field to this acceptance and, in fact, promotion of Halon 1211, was mixed. Primarily, however, the basic issues raised concerned toxicity, and hence the suitability of Halon 1211 in confined occupied spaces.

PROGRAM OBJECTIVES.

The general objective of the study was to conduct a detailed survey of the past, current, and potential use of hand-held extinguishers in civil aviation. The state-of-the-art review was to include a literature search and an analysis of the literature data base, on-site surveys of manufacturers and users within the United States, and an analysis of the capabilities of various hand-held extinguishers in aircraft environments.

INFORMATION SOURCES

LITERATURE SEARCH.

To obtain reference to pertinent technical reports and papers, FMRC used its in-house, on-line search capability of over 100 bibliographical data bases through interaction with the Lockheed Dialog^R System. Concentration was placed on the following data bases: National Technical Information Service (NTIS); COMPENDEX (Engineering Index); Transportation Research Information Service (TRIS); SSIE/current research. Key words used were hand-held and all forms of the root word extinguish. Titles, report description, and abstracts were searched for the presence of the desired key words. This search yielded abstracts as follows: 376 from NTIS; 79 from TRIS; 160 from COMPENDEX; and 20 from SSIE current research. The abstracts were reviewed and pertinent documents were selected and ordered if not already in-house. In addition to the on-line search, a manual search was conducted to review related journals and magazines. Among those were Fire Research Abstracts and Reviews, 1960-1976; Fire Technology Abstracts, volume 1, number 1, 1977 - volume 3, number 5, March 1979 (latest); References to Scientific Literature on Fire, Borehamwood 1960-1979 (latest); Current Contents, Engineering and Technology, 1975-1980; National Fire Protection Association (NFPA) Fire Journal 1965-1980; NFPA Quarterly 1960-1964. Current codes, standards, testing procedures, and regulations which relate to the subject of hand-held extinguishers were also reviewed in detail as appropriate. Of particular import to this project are the following NFPA documents: NFPA 10 Portable Fire Extinguishers 1978; NFPA 12A Halon 1301 Fire Extinguishing Systems 1980; NFPA 12B Halon 1211 Fire Extinguishing Systems 1980; NFPA 12 Carbon Dioxide Fire Extinguishing Systems; 1980; NFPA 17 Dry Chemical Fire Extinguishing Systems 1980; NFPA 408 Aircraft Hand Fire Extinguishers (currently in draft revision); UL 711 Rating and Fire Testing of Fire Extinguishers 1979; current Underwriters' Laboratories listings and safety standards and current Factory Mutual Approvals and Approval Standards pertaining to hand-held fire extinguishers.

Further, all indexes and subject folders in the extensive Factory Mutual Research Corporation Technical Library were reviewed for pertinent data. Included in this effort was a recent literature search on Halons.

Aside from standards and regulations, the total literature search yielded approximately 30 reports and papers of direct value in addition to various worthwhile magazine and journal articles. It should be recognized that proprietary information cannot be obtained through normal literature search routes. Such data can only be discovered and possibly obtained through personal contacts. Worthwhile documents (excluding Standards and Regulations) are listed in the references.

VISITS AND PERSONAL CONTACTS.

During the conduct of the program many organizations were provided the opportunity to contribute information, policy and ideas. Visits were made to numerous organizations and companies that have a direct interface with the subject of hand-held extinguisher selection for civil aviation aircraft. In addition to actual visits, telephone discussions were considered adequate for other organizations when it was determined that a visit would contribute no additional benefit to the program. Organizations contacted included aircraft operators, aircraft manufacturers, agent and extinguisher manufacturers, independent approving and regulatory agencies, concerned organizations and federal regulatory agencies. During all visits, current policy, future plans, related testing, fire loss data and flight attendant hand-held training were discussed as appropriate.

Specifically, visits were made to ten commercial airlines flying large aircraft; American Airlines, Continental Airlines, Delta Airlines, Eastern Airlines, Northwest Airlines, Republic Airlines, Trans World Airlines, United Airlines, US Air, and Western Airlines. Visits were made to several small taxis and commuters, two cargo carriers, and numerous private and business owners. Visits were also made to large airframe manufacturers (Boeing, Lockheed, and McDonnell Douglas) and small aircraft manufacturers (Beechcraft, Cessna, and Gates Lear).

During the 1980 Annual NFPA meeting discussions were conducted with representatives of various extinguisher and agent manufacturers. Included were Imperial Chemical Industries (ICI), Dupont, 3M, Kidde, Ansul, Graviner and General.

Visits were also made to major interfacing groups: the Air Transport Association (ATA); the Airlines Pilots Association (ALPA); the Association of Flight Attendants (AFA); and the National Academy of Sciences. The Aircraft Owners and Pilots Association (AOPA) was surveyed by telephone.

Government agencies visited included the U.S. Coast Guard, Air Force, Army and Navy; the National Aeronautics and Space Administration; the National Transportation Safety Board; and the FAA. Within the FAA numerous individuals in many offices were contacted to obtain a proper understanding of the interrelationship and overall picture of the hand-held extinguisher issue. Specifically, such visits included: Office of Civil Aviation Security; Office of Aviation Medicine; Office of Airworthiness, (Aircraft Maintenance and Aircraft Engineering Divisions); Office of Aviation Safety (Accident Investigation and Safety Analysis Division); Civil Aeromedical Institute; and three FAA regional offices (southwest, central and southern).

The result of such an extensive visit schedule was basically very productive. Much proprietary data including correspondence, memos, test results, and reports were obtained which otherwise would probably have been unavailable. In addition to such written data, informal discussion often yielded immensely valuable input. Of particular value was information relating to air carrier and aircraft manufacturer views, opinions, and policies, as well as their rationale for such positions relating to hand-held fire extinguishers. It should be noted that information obtained through personal contacts provides input throughout this report.

RECENT EXTINGUISHER SELECTION HISTORY IN CIVIL AVIATION

COMMERCIAL AVIATION.

During the conduct of on-site visits it became clear that the major carriers were currently using water extinguishers and CO₂ or water extinguishers and dry chemical, with CO₂ being used in the majority of cases. It also became apparent that the large airframe manufacturers basically sold aircraft in one of three ways: (1) in addition to water, the customer specified the type of extinguisher to be installed; (2) the customer supplied the extinguishers to be installed; or (3) the customer accepted the manufacturer's "baseline" extinguisher selection. The first option represents the large majority of U.S. carrier purchases. The carrier selection in recent years has primarily been made on the basis of standardization or uniformity as much as possible.



It should be recognized that Boeing has certificated (mid 1979) all its available aircraft (including the 757 and 767) with Halon 1211 extinguishers in addition to water as baseline equipment. Lockheed and Douglas will supply Halon 1211 as a customer-ordered option.

Each manufacturer has, depending on interior layout, configured its aircraft with extinguishers generally located at galleys and/or doors in numbers which, for large aircraft passenger compartments, meet or exceed those required by the FAR. Figures 1, 2, and 3 are typical and indicate numbers and locations for several Boeing aircraft. Figure 4 shows the configuration for one carrier's selection for a Boeing 747 which exceeds the manufacturer's standard (Figure 3) by two dry chemical extinguishers.

There is clearly a trend toward the present and future use of Halon 1211 extinguishers for commercial aviation. For the most part this has resulted from the FAA General Notice previously referenced. In addition, other factors have had some effect: (1) the Revised AC 20-42A; (2) increased difficulty in obtaining parts and new dry chemical units for carriers using Ansul dry chemical extinguishers. (Effective 11/1/79 Ansul has withdrawn from the aviation market by corporate decision.); (3) weight advantage of Halon 1211 over CO₂ and (4) lack of a commercially available FM-approved, UL-listed, or Coast Guard-approved Halon 1301 extinguisher. The carriers who plan to utilize Halon 1211 extinguishers indicate that it is their intention to retrofit their entire fleet by replacing all dry chemical or CO₂ extinguishers in passenger compartments with Halon 1211. This decision was apparently made for purposes of standardization resulting in obvious advantages to training and maintenance. Those carriers resisting or undecided indicated that there were unanswered agent toxicity issues and/or that the Technical Center tests (which led to the General Notice) were not representative of the actual enclosed passenger-filled fire environment. Apparently, also for toxicity reasons, there was some indecision among the carriers who planned to retrofit passenger compartments as to whether flight deck CO₂ extinguishers would also be retrofitted.

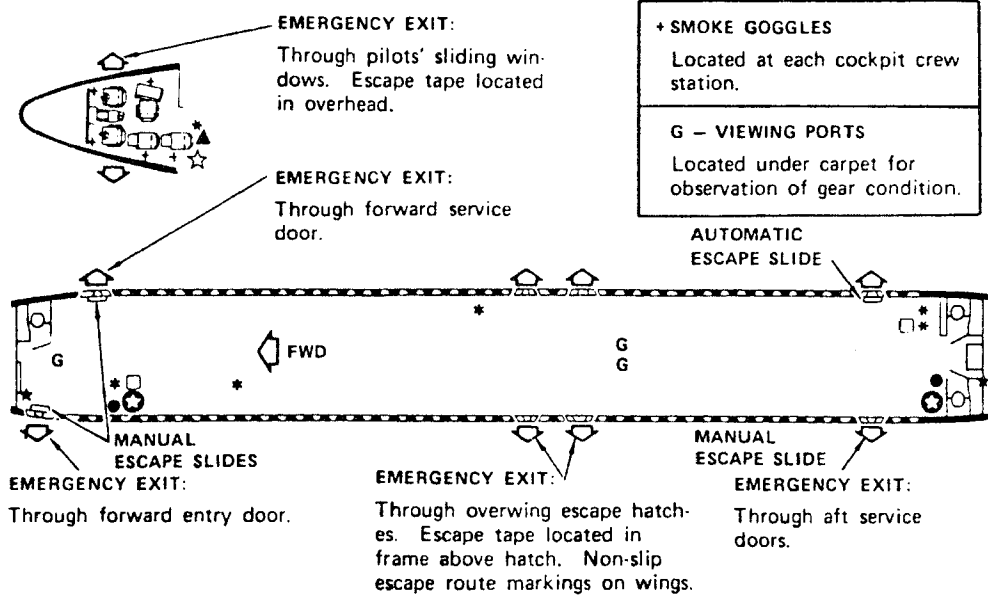
While discussing what is currently being done, it should be recognized that all large passenger aircraft carry water extinguishers. There is no intent on the part of the carriers to replace or eliminate those extinguishers. The clear purpose for carrying water extinguishers is to meet the intent of the FAR and provide the capability for typical Class A fires.

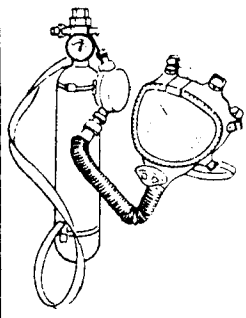
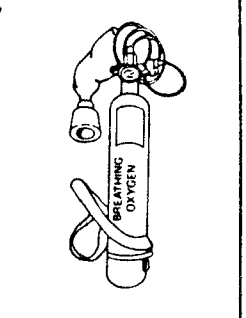
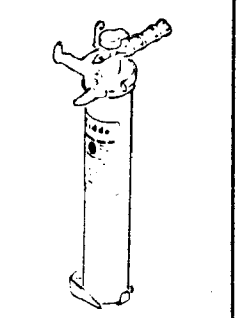
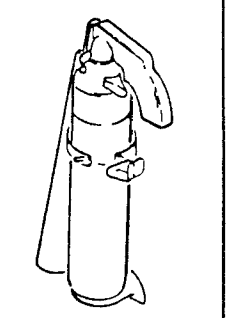
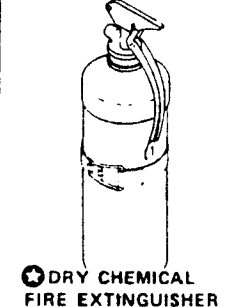
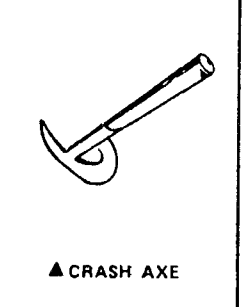
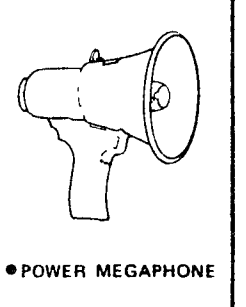

			
* CREW PORTABLE OXYGEN	* PASSENGER PORTABLE OXYGEN	* WATER FIRE EXTINGUISHER	☆ CO ₂ FIRE EXTINGUISHER
			
● DRY CHEMICAL FIRE EXTINGUISHER	▲ CRASH AXE	● POWER MEGAPHONE	□ FIRST AID KIT

EMERGENCY EQUIPMENT LOCATION

FIGURE 1 EXTINGUISHER PROVISIONS
BOEING - 727

OPERATIONS MANUAL

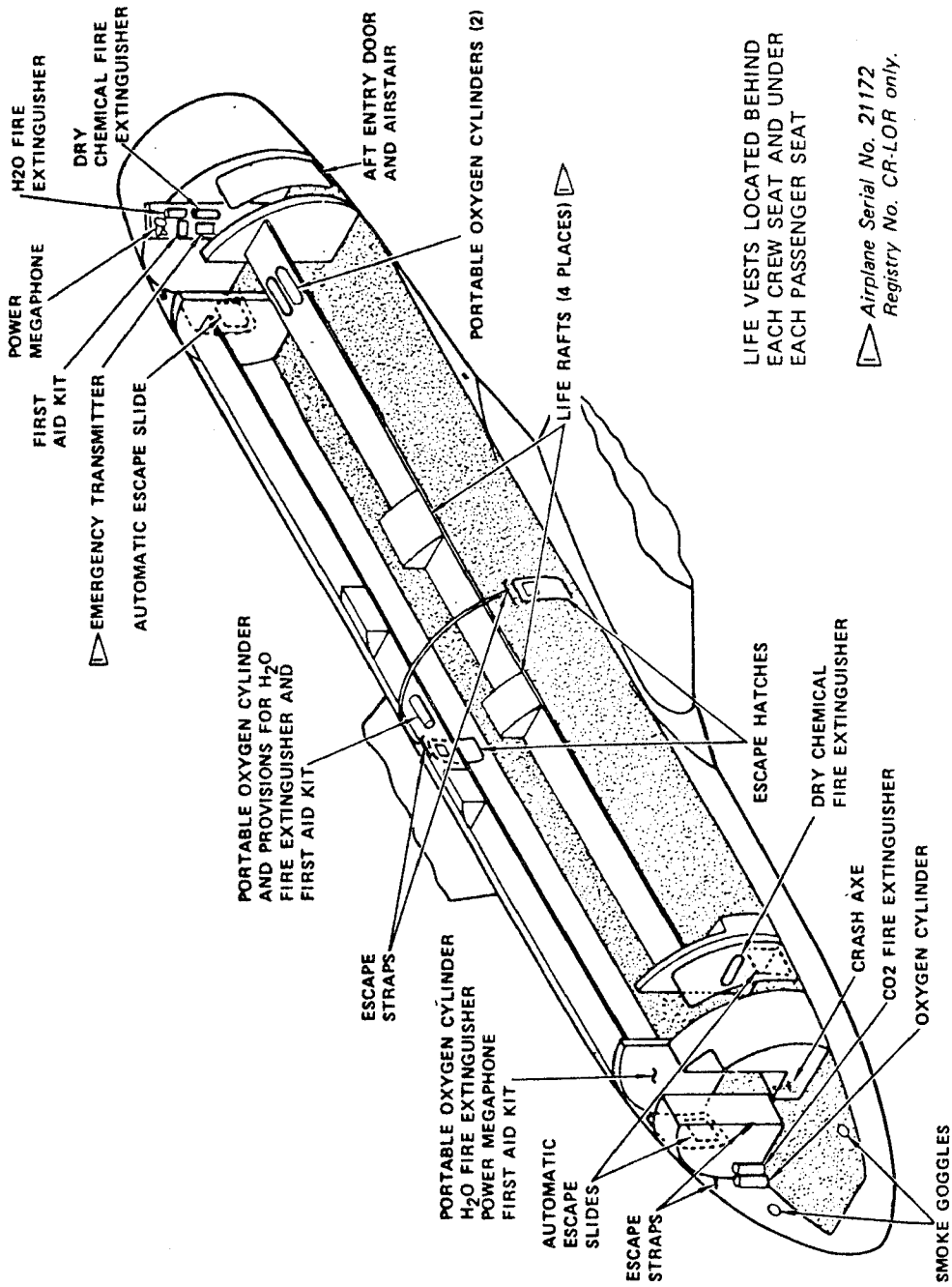

EMERGENCY EQUIPMENT LOCATION

**FIGURE 2 EXTINGUISHER PROVISIONS
BOEING - 737**

EMERGENCY EQUIPMENT	CREW STA	STUB PART	P6 PANEL	UPR DK DOOR	STOW AREA	STAIR-WELL	LOUNGE AREA
SMOKE GOGGLES	5						
LIFE VESTS	5						16
O2 BOTTLES & MASK		1				1	
FIRST AID KIT		1					
CRASH AXE		1					
ESCAPE REELS (CEILING)			5				
CO2 EXTINGUISHER			1				
INFLATABLE SLIDE				1			
H2O EXTINGUISHER						1	
SMOKE BARRIER						1	

COCKPIT AND LOUNGE

EMERGENCY EQUIPMENT	DOOR 1		DOOR 2		DOOR 3		DOOR 4		DOOR 5	
	LH	RH	LH	RH	LH	RH	LH	RH	LH	RH
O2 BOTTLES (UNDER OUTBOARD PASSENGER SEAT)	2	2	2	2	3	3	2	2	3	2
CHEM EXT (OUTBD OF ATTENDANTS SEAT BUSTLE)	1		1				1			
H2O EXT (OUTBD OF ATTENDANTS SEAT BUSTLE)		1						1		1
MEGAPHONE (IN OVERHEAD SIDE STOWAGE BIN)	1						1			
FIRST AID KIT (IN CLOSET)	1						1	ovhd		1
CRASH AXE (IN CLOSET)									1	1
SPARE LIFE VESTS (UNDER ATTENDANTS SEAT)	5	5	5	2	5	2	5	2		
SPARE LIFE VESTS (IN CLOSET)									6	8
INFLATABLE SLIDE (ON DOOR)	1	1	1	1			1	1	1	1
INFLATABLE RAMP AND OFF-WING ESCAPE SLIDE					1	1				
ESCAPE ROPES					1	1				
ATTENDANTS LIFE VEST (UNDERSEAT STOWAGE)	2	2	2	1	2	1	2	1	1	1
LIFE RAFT PROV. (OVERHEAD)	2	2	2	2	3	2	2	2	2	2
AUTO. RADIO BEACON (IN RAFT COMPARTMENT)	1						1	1		1

PASSENGER CABIN

EMERGENCY EQUIPMENT AND LOCATION

FIGURE 3 EXTINGUISHER PROVISIONS
BOEING - 747

EMERGENCY SAFETY EQUIPMENT - 747

The diagram to the right shows the various items of equipment located in designated areas, as assigned to individual F/As for the Preflight Safety Inspection. Below are the checks/conditions required:
 Door Pwr Assist & Wing Ramp Pressure Gages - pointer should be in the green band.

Emergency Lights switch - should be in NORMAL (light not on)
 Oxygen Bottle - pointer on pressure gage normally will be in the red band and there should be a KS mask taped to the side of the bottle (in each galley one bottle should have a smoke mask attached and excess hose should be stowed in the box).

Note: If the temperature of the oxygen bottle is colder than normal cabin temperature, the pointer may be below the red band even on a fully charged bottle. Only maintenance can determine if the pressure is above minimum for a cold-soaked bottle.

Fire Extinguishers

Water & handle should be safety wired.

Dry Chemical

Cockpit - CO2

The pressure gage pointer should be in the green band.

Megaphone (voice gun) - push the button and listen for an audible "pop".
 First Aid Kit - the seal should be intact

Escape hatch - open and close to check operation.

Life Rafts and Ditching Lines - compartments should be closed and latched. (To check if compartment contains a life raft, PUSH UP the flap labeled "liferaft" until overhaul placard is visible through the opening.)

Life Vests - check extras stowed and spot check installed under seats.

Emergency flashlights

Red battery condition light should be blinking

NOTE

Life vests are installed under all seats in forward and main cabins, under 8 seats in the Upper Deck lounge, and under all jump seats.

3R Door Pwr Assist Pressure gage
 Wing Ramp Pressure gage
 Oxygen Bottles (2)
 Escape Line
 Fire Extinguisher (water)
 Rafts 10 & 11 (transceiver in 10)
 Crew Life Vest
 Emergency flashlight

STOWAGE CABINET
 *Child Life Vests (10)
 First Aid Kit

4R Door Pwr Assist Pressure gage
 Oxygen Bottles (2)
 Rafts 9 & 16
 Crew Life Vest
 Emergency flashlight

UPPER DECK LOUNGE
 Oxygen Bottle
 Fire Extinguisher (water)
 Cockpit key
 Emergency flashlight
 Door Pwr Assist Pressure gage
 Fire Extinguisher (water)
 *Raft 8 (transceiver)
 Crew Life Vest (2)
 Emergency flashlight (2)

1R Door Pwr Assist Pressure Gage
 Oxygen Bottles (2)
 *Raft 6 (transceiver)
 Crew Life Vest (2)
 Emergency flashlight (2)

2L Door Pwr Assist Pressure gage
 Oxygen Bottles (2)
 Fire Extinguisher (dry chemical)
 *Raft 5 & 7
 Crew Life Vest (2)
 Emergency flashlight (2)

*Raft 1 (transceiver)
 Emergency flashlight (2)
 FWD COAT CLOSET
 *Child Life Vests (10)
 Adult Life Vests (6)
 First Aid Kit
 KS masks (2)

30-4
 11/26/80

5R Door Pwr Assist Pressure gage
 *Rafts 19 & 20 (transceiver in 20)
 Crew Life Vest
 Emergency Flashlight
 AFT RIGHT COAT CLOSET
 Oxygen Bottle
 Fire Extinguisher (water)
 First Aid Kit
 AFT LEFT COAT CLOSET
 Oxygen Bottles (2)

AFT LEFT STOWAGE CLOSET
 *Child Life Vests (10)
 *Adult Life Vests (6)

5L Door Pwr Assist Pressure gage
 *Raft 19 (Transceiver)
 Crew Life Vest
 Emergency flashlight
 Door Pwr Assist Pressure gage
 Oxygen Bottles (2)
 Fire Extinguisher (dry chemical)
 Megaphone
 *Rafts 13 & 15
 Crew Life Vest (2)
 Emergency flashlight (2)

3L Door Pwr Assist Pressure gage
 Wing Ramp Pressure gage
 Oxygen Bottles (2)
 Escape Line
 *Rafts 9 & 11 (transceiver in 9)
 Crew Life Vest (2)
 Emergency flashlight (2)
 GALLEYS (each)
 Fire Extinguisher (2)
 First Aid Kit
 Fire Extinguisher (dry chemical)
 Oxygen Bottles (2)
 (1 with smoke mark)
 Escape hatch
 Emergency flashlight

* Not required on domestic flights.

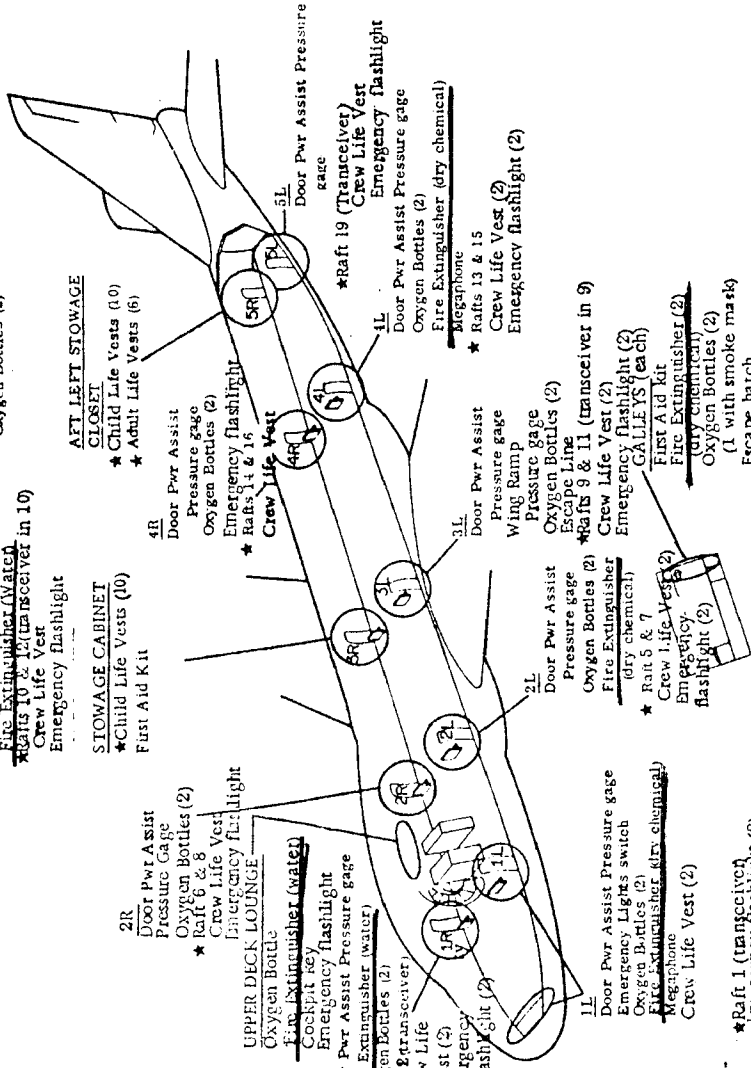

FIGURE 4 EXTINGUISHER PROVISIONS BOEING-747 AS EQUIPPED BY ONE AIRLINE

Virtually all water extinguishers used on planes are the Kidde unit containing approximately 1 1/3 quarts of water expelled by means of a CO₂ cartridge. The quantity of water, in fact, is based upon how much liquid the CO₂ cartridge could expel. According to UL 711, Rating and Fire Testing of Fire Extinguishers, 1 1/2 gallons of water are required to provide a 1-A rating. If one extrapolates, the 1 1/3-quart water extinguisher has an equivalent of approximately 1/4 of a 1-A rating capability. Therefore, to provide for a 1-A capability, four such water extinguishers would be required. Only specially equipped widebodies (such as in Figure 4) have such total capability and the units are located from the forward upper deck to the fifth right door.

GENERAL AVIATION.

There are no airworthiness extinguisher requirements (FAR part 23) for most general aviation aircraft. Only large corporate aircraft certified under FAR Part 25 must be equipped with an FAA approved extinguisher. It is, therefore, difficult to accurately determine population breakdown in actual field use. There are also no extinguisher requirements (FAR part 91) for the operation of general aviation aircraft other than large and turbine-powered multiengine airplanes. Small airframe manufacturers do offer hand-held extinguishers as options; Beech, as long ago as 1962, offered as a standard option Halon 1301 extinguishers. Due to availability problems, Beech, ultimately (1975) selected Halon 1211 as its standard option. Piper and Cessna now also offer Halon 1211 as an option. Dry chemical is still available as an option on various aircraft models.

Those aircraft not purchased with an extinguisher option are often equipped by the owner. For the most part selection has been made on the basis of accessibility and relative low cost. It is believed that the majority of owner-equipped and older manufacturer-equipped aircraft have dry chemical extinguishers installed, with most of the remainder having CO₂ extinguishers.

In recent years at least one company has designed a fixed fire extinguishing system using Halon 1301 for general aviation aircraft. The FAR's do not specifically make reference to fixed extinguishing systems in occupied spaces. A well designed, fixed, total flooding fire extinguishing system sized to provide an acceptable agent concentration (along with ventilation guidelines) will be at least as effective as hand portables with the advantage of automatic capability. In fact, several models of Beech, Cessna, and Piper have supplemental-type certificates with such a system.

It should be noted that in recent years, the issue of suitable Halon concentrations specifically for general aviation aircraft has been hotly debated within the FAA as spearheaded through the FAA Central Region. Because of the small volumes of General Aviation (GA) cabins, the concentration issue for GA is more critical as to human exposure limits than for the passenger cabins of large commercial transports.

RECENT FIRE INCIDENT HISTORY

It became evident during the conduct of this program that the readily accessible data bases accumulating information on aircraft cabin fires (cockpit, passenger, cargo) were less than perfect. The largest pertinent data base (in terms of numbers of incidents) results from Service Difficulty Reports (SDR) and is maintained by the FAA in Oklahoma City. This data base, comprised of Air Carrier and General Aviation incidents, has been computerized since January 1976. However, little narrative is associated with these records which is typical of computerized data bases. The National Transportation Safety Board (NTSB) also maintains a computerized data base. They accumulate data on Accidents (as opposed to Incidents) which occur between time of boarding and complete deplaning for both General Aviation and U.S. Air Carriers. Figure 5 provides the NTSB definition for Accident as well as other definitions used in the data bases. All reported occurrences not described as Accidents should be included in the FAA SDR data base. It should also be recognized that NTSB reports are only generated for accidents which occur on or over U.S. soil. An accident which occurs on or over foreign soil involving a U.S. manufactured and/or certificated aircraft would result in a report issued by that foreign country even though the United States may assist in the investigation. The NTSB data base was computerized in 1962 for Air Carriers and in 1964 for General Aviation, although it was only possible to obtain printouts specifically related to fire since 1974 for Air Carriers, and since 1975 for General Aviation.

Figure 6 (SDR submission form) indicates the type of information collected in the SDR data base. Fire and smoke incidents may be abstracted by selecting records which have an A or a B coded for Nature of Condition (item U in Figure 6). General location on or within the aircraft is provided by Air Transport Association (ATA) code. Stage of operation, i.e., inflight versus ground maintenance, can be determined by the code for item V. More detailed information must be obtained from the narrative.

In addition to these data bases, one major carrier admits having a computerized base from which, fire incidents may be extracted. This base is limited in that it was implemented in January of 1979, although it contains somewhat more narrative. Several other carriers maintain manual files on fire incidents, which, although providing more narrative, are extremely unwieldy for cumulative analysis and make it virtually impossible to tabulate multivariably. In addition, the NTSB has detailed written reports for accidents which they investigated. Further isolated, fragmented accident/incident reports exist in organizations such as the Association of Flight Attendants (AFA). Additional special reports exist in which specific carrier fire statistics are provided (References 1 and 2). The major airframe manufacturers also maintain manual files relating to fire for various aircraft.

A computer run containing pertinent (fire and smoke) SDR records was obtained from the FAA. The records were individually reviewed for pertinence to this study. For those selected, key data including certain special data from the narrative were recoded and entered into a new Factory Mutual Research Corporation (FMRC) computer data base such that various cross variable analyses could easily be conducted. Additional coded data obtained from the narrative consisted of Yes or No items of special interest: i.e., stated use of an extinguisher; stated smoking materials involved; fire of electrical origin. Using the ATA code and the narrative, a fire location group was also determined. Occurring during the time period January 1976 through approximately mid March 1981, 321 incidents of interest were recoded to form the new FMRC data base. Of that number, 238 (74 percent) involved aircraft

GENERAL AVIATION

General Aviation refers to the operation of U.S. Civil Aircraft owned and operated by persons, corporations, etc., other than those engaged in U.S. air carrier operations. (U.S. air carrier operations include the certificated route air carriers, supplemental air carriers, and commercial operators of large aircraft).

AIRCRAFT ACCIDENT

The accidents included herein are the occurrences incident to flight in which, "as a result of the operation of an aircraft, any person (occupant or nonoccupant) receives fatal or serious injury or any aircraft receives substantial damage." The definition of substantial damage is:

- (1) Except as provided in subparagraph (2) of this paragraph, substantial damage means damage or structural failure which adversely affects the structural strength, performance, or flight characteristics of the aircraft, and which would normally require major repair or replacement of the affected component.
- (2) Engine failure, damage limited to an engine, bent fairings or cowling, dented skin, small punctured holes in the skin or fabric, ground damage to rotor or propeller blades, damage to landing gear, wheels, tires, flaps engine accessories, brakes, or wingtips are not considered "substantial damage" for this part.

INJURY INDEX

Injury index refers to the highest degree of personal injury sustained as a result of the accident.

FATAL INJURY

Any injury which results in death within 7 days of the accident.

SERIOUS INJURY

Any injury which 1) requires hospitalization for more than 48 hours, commencing within 7 days from the date the injury was received; 2) results in a fracture of any bone (except simple fractures of fingers, toes, or nose); 3) involves lacerations which cause severe hemorrhages, nerve, muscle, or tendon damage; 4) involves injury to any internal organ; or 5) involves second- or third-degree burns, or any burns affecting more than 5 percent of body surface.

FIGURE 5 NTSB DATA BASE DEFINITIONS

of DC9 size class and larger; 83 (26 percent) involved smaller aircraft, predominantly 6-seat and smaller. It should be recognized that incidents involving engine fires, wing fires, brake fires, or fires otherwise inaccessible for hand-held extinguisher application were not included in the new FMRC data base. The great majority of SDR recorded incidents involving smaller aircraft were of this type. Of the 238 "larger aircraft" incident records only 22 and 5 were in the taxi and inspection stages of operation respectively. Of those same incidents, 18 (7.7 percent) stated that smoking materials were involved; 154 (65.5 percent) were of electrical origin; and 29 (12.3 percent) stated that a hand-held extinguisher was used. Table 1 provides these data on an annual basis. Of the 83 "smaller aircraft" incidents: 5 (5.8 percent) stated that smoking materials were involved; 74 (86.0 percent) were of electrical origin; and none stated hand-held extinguisher use. Table 2 provides these data on an annual basis. Table 3 is a listing of all incidents in which the use of hand-held extinguishers was stated. As indicated, fire location was grouped into meaningful categories. Of the 238 "larger aircraft" incidents, 168 (70.6 percent) involved galleys and 22 (9.2 percent) involved lavatories. Table 4 provides a complete breakdown by location. Table 5 provides a similar breakdown for the 83 "smaller aircraft" incidents. Table 6 incorporates all 321 incidents. Including all sizes of aircraft, it can be seen that the SDR data base (January 1, 1976-April 8, 1981) represents on the average, 62 incidents per year. For comparison let us review a study (Reference 2) conducted by Lockheed for the FAA in which SDR records over the period January 1968 to February 1975 were reviewed. Table 2-5 of that report defines compartment flame, smoke and overheat incident frequency by zone (all aircraft sizes). The zones were determined by the contractor and include locations inaccessible to hand fire extinguisher application. If those incidents are disregarded, a total of 332 incidents are included which represents an annual average of approximately 47. Table 7 redefines the data from cited Table 2-5 into zones and format similar to Table 6 for comparison. As can be seen, neither the relative number (assuming fleet growth) nor the location distribution has changed greatly.

A computer run containing pertinent records (those involving fire) from the NTSB data base was also obtained. Computer records state for air carriers whether the fire was in flight or on the ground and for general aviation whether the fire was in flight or after impact. This data base contained only one air carrier accident (1974-1978) which involved an in-flight cabin fire in a location accessible to hand-held extinguisher action. This accident (2/16/74) involved a TWA 707 in which a coffee maker exploded and resulted in one "serious" injury. This data base also contained only six general aviation accidents (1975-1979) which involved in-flight interior fires (five cabin, one baggage compartment).

The FAA also maintains another computerized data base called Accident/Incident Data Systems (AIDS). This data base was initiated in 1976 and is largely made up from preliminary accident reports (within five days of occurrence). It is comprised of both Air Carrier Incidents and General Aviation Accidents/Incidents, the majority being General Aviation Accidents. In-flight versus on-ground occurrences can be defined easily but cabin versus engine (for the inflights) cannot be determined unless specified in "remarks" (narrative). A Manual review of in-flight fire and explosion records from this data base reveals primarily engine, fuel line, tail and similar locations which are likewise inaccessible with hand-held extinguishers. There is a certain amount of overlap between this data base and the SDR data base, but there are clearly some incident records in AIDS, that are not in SDR. Of 168 in-flight fire/explosion occurrences (1976-January 1981), 12 were Air Carrier incidents of which four were in the cabin (all between 3/19/80 and 1/28/81). Of

TABLE 1 "LARGER AIRCRAFT" INCIDENTS

(Involving Smoking Materials, Electrical Origin, Hand-Held Extinguishers)

Year	Incidents No.	Smoking Materials No. (%)	Electrical Origin No. (%)	Hand-Held Use No. (%)
1976	45	5 (11.1)	31 (68.9)	4 (8.9)
1977	42	3 (7.1)	22 (52.4)	4 (9.5)
1978	55	6 (10.9)	38 (69.1)	8 (14.5)
1979	37	1 (2.7)	24 (64.9)	8 (21.6)
1980	50	3 (6.0)	36 (72)	3 (6.0)
1981	9	- (-)	5 (55.6)	2 (22.2)
TOTAL	238	18 (7.6)	156 (65.5)	29 (12.2)

TABLE 2 "SMALLER AIRCRAFT" INCIDENTS
(Involving Smoking Materials, Electrical Origin, Hand-Held Extinguishers)

Year	Incidents No.	Smoking Materials No. (%)	Electrical Origin No. (%)	Hand-Held Use No. (%)
1976	15	-	14 (93.3)	-
1977	10	1 (10.0)	9 (81.8)	-
1978	8	1 (12.5)	7 (87.5)	-
1979	23	3 (13.0)	21 (91.3)	-
1980	19	-	16 (78.9)	-
1981	8	-	7 (87.5)	-
TOTAL	83	5 (6.0)	72 (86.7)	none recorded

TABLE 3 ALL INCIDENTS INVOLVING HAND-HELD EXTINGUISHER USE

Yr	Date			ATA Code	Location	Aircraft	Airline	Nature	Smoking Materials Involved		Electrical Origin	
	Mo	Day	Yes(Y)						No(N)	Yes(Y)	No(N)	
76	01	05	2522	Cockpit	707	WAL	Smoke	Y			N	
76	04	09	2530	Galley	1011	TWA	Fire	N			Y	
76	05	18	2532	Low Galley	747	AAL	Smoke	N			N	
76	01	20	2522	Passgr. Cabin	707	PAA	Fire	Y			N	
77	03	22	2540	Forward Lav.	747	UAL	Smoke	Y			N	
77	04	21	2540	Upper Galley	DC10	NAL	Smoke	N			N	
77	10	14	2532	Upper Galley	727	CAL	Fire	N			N	
77	10	25	2540	Lavatory	737	SWO	Smoke	N			N	
78	03	22	2540	Lavatory	747	PAA	Fire	Y			N	
78	05	05	2500	Passgr. Cabin	720	WAL	Fire	Y			N	
78	07	28	2532	Galley	DC10	AAL	Smoke	N			Y	
78	10	13	3320	Passgr. Cabin	747	PAA	Fire	N			Y	
78	11	02	2540	Lavatory	DC10	AAL	Smoke	N			N	
78	11	09	2522	Passgr. Cabin	707	SWO	Smoke	Y			N	
78	11	30	2532	Upper Galley	747	SWO	Fire	N			N	
78	12	27	2532	Upper Galley	747	PAA	Fire	N			Y	
79	01	16	2532	Galley	747	SWO	Smoke	N			N	
79	01	23	2540	Aft Lav.	DC9	AWI	Fire	Y			N	
79	05	07	2532	Galley	1011	SWO	Fire	N			N	
79	05	07	2540	Lavatory	747	SWO	Smoke	N			N	
79	08	13	2540	Aft Lav.	737	UAL	Fire	N			N	
79	09	06	2532	Upper Galley	727	WAL	Fire	N			Y	
79	09	18	2532	Low Galley	1011	DAL	Fire	N			N	
79	12	05	2532	Galley	1011	EAL	Fire	N			N	
80	04	21	2540	Lavatory	747	PAA	Smoke	Y			N	
80	05	28	2520	Passgr. Cabin	747	PAA	Fire	N			N	
80	07	21	2500	Passgr. Cabin	DC10	UAL	Smoke	Y			N	
81	01	30	2532	Low Galley	1011	EAL	Fire	N			N	
81	03	02	3320	Passgr. Cabin	747	PAA	Fire	N			Y	

TABLE 4 "LARGER AIRCRAFT" INCIDENTS BY LOCATION

Location	Number	Percent
Galley	168	70.6
Lavatory	22	9.2
Flight Deck	15	6.3
Pass. Cabin	30	12.6
Overhead	-	-
Cargo	1	0.4
Inside (but unknown)	2	0.8
TOTAL	238	100

TABLE 5 "SMALLER AIRCRAFT" INCIDENTS BY LOCATION

Location	Number	Percent
Galley	9	10.8
Lavatories	3	3.6
Flight Deck	41	49.4
Pass. Cabin	17	20.5
Overhead	1	1.2
Cargo	2	2.4
Tail	1	1.2
Inside (but unknown)	9	10.8
TOTAL	83	100

TABLE 6 ALL AIRCRAFT INCIDENTS BY LOCATION

Location	Number	Percent
Galley	177	55.1
Lavatories	25	7.8
Flight Deck	56	17.4
Pass. Cabin	47	14.6
Overhead	1	.3
Cargo	3	1.0
Tail	1	.3
Inside (but unknown)	11	3.4
TOTAL	321	100

TABLE 7 COMPARISON DATA FROM LOCKHEED REPORT(reference 2)

Location	Number	Percent
Galley	148	44.6
Lavatories	33	9.9
Flight Deck	71	21.4
Pass. Cabin	67	20.2
Overhead	7	2.1
Cargo	6	1.8
TOTAL	332	100

these four, two were cockpit smoke/fire incidents and two involved fires caused by passenger smoking materials. None of these four incidents were in the SDR data base. Of the remaining 156 in-flight fire/explosion general aviation records, only 10 were definite cabin/cockpit occurrences.

From an analysis of all sources it is clear that none of the data bases represent 100 percent of the cabin smoke and fire incidents actually occurring; this is due to nonreporting, miscoding and probably many other reasons. Exactly what percent of the population is represented is impossible to determine. For reference, however, one carrier apparently has three to four times the pertinent incidents recorded (January 1, 1979-March 26, 1981) on their computerized data base as does the SDR base.

In summarizing the fire incident/accident data, it is clear that galley fires represent by far the major fire and/or smoke occurrence for the larger aircraft. It should be recognized that some of these result from spilled food, and improperly placed articles in ovens. Electrical flight deck fires are the major fire and/or smoke occurrence for the smaller aircraft. It is also clear that in-flight fires of the magnitude represented by the Varig 707 on July 11, 1973 (reference 3) and the Saudia L1011 fire in 1980 are a small percentage of the total fire and smoke events worldwide. Nevertheless, large in-flight fires represent a threat that must be recognized in extinguisher selection and fire-fighting strategy.

TOXICITY OF PYROLYZED CABIN INTERIOR MATERIALS

Although this subject is technically not within the scope of this effort, the author believes an overview to be important for summary philosophy.

In recent years, a number of large-scale and laboratory-scale tests have been conducted in which the products of combustion of cabin materials used in commercial aircraft were measured. Full-scale tests have been conducted by NASA using older aircraft materials and newer fire-resistant aircraft materials (references 4 and 5). Large-scale tests have been conducted (reference 6) by NASA specifically on fire retardant and other polyurethane foam aircraft seat cushion materials. Much laboratory testing has been conducted on a wide variety of interior finish materials. Sarkos et al (reference 7) in a paper entitled "Laboratory Fire Testing of Cabin Materials Used in Commercial Aircraft, August 1978" summarize various related work as well as an extensive cooperative program between the FAA's Technical Center (then NAFEC) and Civil Aeromedical Institute (CAMI) involving an analysis of 75 in-service materials. In addition, large-scale tests have been conducted which simulate onboard Class A trash and newspaper fires (references 8 and 9).

Without going into great detail here, the literature is clear on the following points:

1. The newer fire retardant materials will produce toxic gases. The concluding remarks of a recent related NASA report contain, "The new materials still produced undesirable gaseous products of decomposition as most organic materials will; however, because the area affected was limited to the ignition source region (rather than propagating), the quantities of such gases (except for hydrogen cyanide) were reduced when compared to tests involving more flammable materials." (reference 4)
2. Even burning "airline" type waste in a confined space such as a lavatory can produce toxic products of combustion and pose a cabin visibility problem. An appropriate overall summation is contained in a report by National Materials Advisory Board of the National Academy of Sciences (reference 10).

"Pyrolysis or combustion products of the polymers used in aircraft construction have been found to include carbon monoxide (CO), carbon dioxide (CO₂), hydrogen cyanide (HCN), oxides of nitrogen (NO_x), ammonia (NH₃), hydrogen sulfide (H₂S), phosgene (COCl₂), and many other compounds.

"From fires in confined spaces, the predominant toxic thermal degradation product is CO. Incapacitating or lethal amounts of CO can develop within minutes.

"At the present time the Committee believes that it is difficult to establish the degree to which combustion and thermal decomposition products from synthetic polymers on board aircraft are involved in hazards to human survival during aircraft fires. It is known, however, that deaths caused by toxic gases generated during in-flight and other aircraft fires have occurred in accidents that might have been otherwise survivable. Additionally, laboratory evidence indicates that smoke can be an important adverse factor in escape and survival due to obscuration of exits, lachrymation, and panic, as well as toxicity."

The intent of the foregoing discussion is to provide perspective to the issue of extinguisher toxicity. As will be discussed later, Halon extinguishing agents do produce toxic products of decomposition when subjected to sufficient heat. However, as referenced in this section, burning aircraft interior materials will produce toxic products of combustion as well as smoke and heat. The decomposition of a Halon extinguishing agent could (at some point in time) introduce some incremental toxicity to a fire scenario but it could also add fire-fighting capability with increased likelihood of extinguishment. If a difficult cabin fire is not extinguished rapidly, some or all occupants could die from the inhalation of toxic products of combustion.

AGENTS AND EXTINGUISHERS

SUPPRESSION CAPABILITY TESTS.

It was stated previously that the volatile liquid hijackings led to the involvement of the Office of Civil Aviation Security. A series of tests (reference 11) were sponsored at the FAA Technical Center in Atlantic City, in which the performance of various types of aircraft hand-held extinguishers were compared on fires meant to be representative of the potential hijack scenario. Aircraft seats were doused with volatile liquid and ignited. The majority of tests involved a fuel quantity of one quart with surplus double or triple passenger seats. Tests were conducted outdoors, indoors, and a few inside a test C-133 fuselage. Extinguisher types used were dry chemical, water, CO₂, and Halon 1211. A total of 22 tests were conducted with various changes in the test parameters. Some tests were witnessed by representatives of the air carrier industry. The outcome of these tests pointed to Halon 1211 as the best agent tested. As indicated previously, carriers resisting the FAA recommendation to add Halon 1211 to their aircraft did so on the basis of several issues of which the foremost is believed to have been toxicity. (This issue is addressed later in this section.) However, other issues raised by individuals who had been present at tests included the representativeness of the tests and the reignition witnessed with Halon 1211 in some tests. The only other live fire tests of which the author is aware on simulated aircraft passenger compartment scenarios using Halon 1211 and other types of extinguishers in comparison were conducted by Boeing and by American Airlines.

Boeing would not release their test data, but the author was made to understand that several Class A fire scenarios were used: i.e., laboratory, newspaper, etc. The test program was conducted as a general evaluation in 1976 with the hope of standardizing on a single extinguisher type. Halon 1301 was eliminated from the evaluation by analysis. Halon 1211 was directly tested against water on the Class A fires. The Halon 1211 extinguishers worked better than water extinguishers in all tests except a large newspaper fire. On the basis of these data, Boeing made a commitment to the use of Halon 1211 and came very close to recommending the elimination of water. These data are significant in view of the comparison made (in Section 4.1) between water and Halon 1211 Class A fire ratings. The weight of 1 1/3 quarts of water is approximately 2 3/4 pounds and this is approximately the contents of a Halon 1211 (nominal 2 1/2-3 pound) extinguisher. Not only are water and Halon 1211 equivalent then on a Class A rating per weight basis, but also on a specific aircraft scenario test basis.

A series of tests (reference 12) was conducted by American Airlines in late August 1980 after the start of the volatile liquid hijackings. These tests were performed on aircraft carpeting and seatcover fabrics and cushions to determine the flame and smoke characteristics of these materials when exposed to ignited volatile liquid (16 or 32 ounces) and to evaluate the effectiveness of CO₂ and Halon 1211 extinguishers on the materials. It was concluded from the tests that (1) such fires are readily extinguished by CO₂; (2) Halon 1211 was as effective; (3) such fires in cabin interiors would cause excessive black dense smoke in 5-10 seconds; and (4) the Halon 1211 left behind a strong bromine smell that caused burning eyes and coughing. It should be noted that the tests with Halon 1211 were conducted inside a 20 x 20 x 30 foot room, while the CO₂ tests were conducted outside.

Another series of tests of significance to this program was conducted for the Air Force Aero Propulsion Laboratory (reference 13) by the FAA Technical Center. While these tests did not specifically address cabin fire scenarios similar to the hijack scenario, they did directly compare Halon 1011, Halon 1211, Halon 1301 and Halon foam. The objective of the program was to determine which of the three latter extinguishants would be the best replacement for Halon 1011 in portable units. The relative effectiveness of the units was compared including fire fighting and combustion product environment. Neat agent concentrations were determined under both quiescent and ventilated nonfire conditions. Test conclusions include: (1) maximum expected volumetric concentration of agent for 100 ft³ per pound of agent discharge is 2.3 percent for Halon 1301 and 2.1 percent for Halon 1211; (2) under quiescent conditions Halon 1211 and Halon 1301 will cause a stratified smoke layer to settle near the floor; and (3) Halon foam had no advantages over pure Halon 1211 or Halon 1301. The final conclusion of the test effort was a recommendation to replace Halon 1011 with Halon 1211. It should be noted that comparative pyrolysis data (CO, CO₂, HBr, HF) is presented for a "deep seated" Class A fire (cotton batting), but not much emphasis is placed on differences between 1211 and 1301. The primary emphasis was that Halon 1011 is significantly worse than the other Halons on a smoldering fire. It appears that, to a large degree, the selection of Halon 1211 was made on the basis of effective range testing.

One additional effort of direct significance to this project should be mentioned. Although not involving tests, "an evaluation for the location and type of hand portable fire extinguisher used on board the AH-1 Army Helicopter" (reference 14) was conducted in 1975. In this study, CO₂ and dry chemical were determined to be unsuitable for the two-seat, 45-ft³ cabin area. Halons 1301, 1202, and 1011 were evaluated for this application and Halon 1301 was determined to be the best choice.

AGENT AND EXTINGUISHER CHARACTERISTICS.

The most basic characteristics of extinguishers are the type and size of fire for which they are suitable. Figure 7 extracted from NFPA 10, Portable Fire Extinguishers 1981 provides definitions for Class A,B,C, and D fires as well as general criteria for Class A,B,C, and D ratings. From Appendix A of NFPA 10 is the following related material.

"Currently Underwriters' Laboratories Inc., and Underwriters' Laboratories of Canada classify extinguishers for use on Class A fires with the following ratings: 1-A,2-A,3-A,4-A,6-A,10-A,20-A,30-A, and 40-A. Effective June 1, 1969, extinguishers classified for use on Class B fires have the following ratings: 1-B,2-B,5-B, 10-B,20-B,30-B,40-B,60-B,89-B,120-B,160-B,240-B,320-B,480-B and 640-B. Ratings from 1-A to 20-A and 1-B to 20-B, inclusive, are based on indoor fire tests; ratings at or above 30-A and 30-B are based on outdoor fire tests."

"For Class B fires it must be recognized that the amount of fire which can be extinguished by a particular extinguisher is related to the degree of training and experience of the operator."

"For fire extinguishers classified for use on Class C fires, no numeral is used since Class C fires are essentially either Class A or Class B fires involving energized electrical wiring and equipment. The size of the different suitable extinguishers installed should be commensurate with the size and extent of the Class A or Class B components, or both, of the electrical hazard or containing equipment being protected."

"For extinguishers classified for use on Class D fires, no numeral is used. The relative effectiveness of these extinguishers for use on specific combustible metal fires is detailed on the extinguisher nameplate."

"Extinguishers which are effective on more than one Class of fire have multiple letter and numeral-letter classifications and ratings."

To qualify for a Class A rating from Underwriters' Laboratories it is necessary to meet minimum performance criteria on an excelsior fire, a wood crib fire, and a wood panel fire. The excelsior fire test for a 1-A rating involves 6 pounds of fuel distributed over a 2 foot 10 inch by 5 foot 8 inch test area. From Underwriters' Laboratories standard UL711, Rating and Fire Testing of Fire Extinguishers comes the following additional information. "The excelsior is to be new and of seasoned basswood, poplar or aspen in a dry state. It is to be pulled apart and spread evenly and loosely over a prescribed test area and then packed to a depth of one foot. The floor of the test area is to be a dry steel plate or dry concrete in all cases." The wood crib test for a 1-A rating involves the extinguishment of a crib comprised of 50 wood members, nominally 2 inch by 2 inch by 20 inch in size, arranged in 10 layers of 5 members each. The ignition of the crib is accomplished with a 21 inch by 21 inch by 4 inch pan charged with 1/4 gallon of n-Heptane. The wood panel test is more complicated and involves an 8 foot by 8 foot panel sprinkled uniformly with one gallon of fuel oil and ignited with excelsior and 2 to 4 ounces of n-Heptane. Specific details for test construction, arrangement, ignition, fire attack strategy, and acceptance criteria for 1-A to 40-A ratings can be found in UL711.

Definitions.

The basic types of fires are Classes A, B, C, and D as defined in the following subsections.

Class A fires are fires in ordinary combustible materials, such as wood, cloth, paper, rubber, and many plastics.

Class B fires are fires in flammable liquids, oils, greases, tars, oil base paints, lacquers, and flammable gases.

Class C fires are fires which involve energized electrical equipment where the electrical nonconductivity of the extinguishing media is of importance. (When electrical equipment is de-energized, extinguishers for Class A or B fires may be used safely.)

Class D fires are fires in combustible metals, such as magnesium, titanium, zirconium, sodium, lithium, and potassium.

Classification and Ratings of Fire Extinguishers.

Portable fire extinguishers are classified for use on certain classes of fires and rated for relative extinguishing effectiveness at a temperature of plus 70°F (21.1°C) by nationally recognized testing laboratories. This is based upon the preceding classification of fires and the fire-extinguishment potentials as determined by fire tests.

The classification and rating system described in this standard is that used by Underwriters Laboratories Inc., and Underwriters' Laboratories of Canada and is based on extinguishing preplanned fires of determined size and description as follows:

CLASS A RATING — Wood and excelsior.

CLASS B RATING — Two-in. (5.1 cm) depth n-heptane fires in square pans.

CLASS C RATING — No fire test. Agent must be a nonconductor of electricity.

CLASS D RATING — Special tests on specific combustible metal fires.

FIGURE 7 BASIC FIRE TYPES AND EXTINGUISHER RATINGS
(from NFPA 10, Portable Fire Extinguishers 1981)

To qualify for a Class B rating from Underwriters' Laboratories it is necessary to meet minimum performance criteria on an n-Heptane fire. Table 8 from UL711 shows the basic fire test parameters for 1-B to 20-B ratings. Additional information may again be found in UL711.

In addition to the size and type of fires for which an extinguisher is suited, the extinguishing agent has certain physical properties and basic characteristics. These characteristics include: around-object capability, corrosion potential, visibility in confined spaces, nominal range, toxicity rating, and ease of cleanup.

The extinguishing agents used in this country for hand portable fire extinguishers are Carbon Dioxide, water, Halon 1211 and various forms of Dry Chemical. Halon 1301 has also been used in hand-held fire extinguishers in recent years. Although not currently available, it is reasonable to expect Halon 1301 hand-held extinguisher availability in the near future.

From NFPA 12, Carbon Dioxide Extinguishing Systems is the following general information.

"Carbon dioxide is a colorless, odorless, electrically nonconductive inert gas that is a suitable medium for extinguishing fires,"

"Carbon dioxide extinguishes fire by reducing the concentrations of oxygen and/or the gaseous phase of the fuel in the air to the point where combustion stops."

"Carbon dioxide fire extinguishing systems are useful within the limits of this standard in extinguishing fires in specific hazards or equipment, and in occupancies where an inert electrically nonconductive medium is essential or desirable, where cleanup of other media presents a problem, or where they are more economical to install than systems using other media."

From NFPA 12A, Halon 1301 Fire Extinguishing Systems and NFPA 12B, Halon 1211 Fire Extinguishing Systems is the following general information on halogenated compounds and the Halon nomenclature system.

"A halogenated compound is one which contains one or more atoms of an element from the halogen series: fluorine, chlorine, bromine and iodine. When hydrogen atoms in a hydrocarbon compound, such as methane (CH_4) or ethane (CH_3CH_3) are replaced with halogen atoms, the chemical and physical properties of the resulting compound are markedly changed. Methane, for example, is a light, flammable gas. Carbon tetrafluoride (CF_4) is also a gas, is chemically inert, nonflammable and extremely low in toxicity. Carbon tetrachloride (CCl_4) is a volatile liquid which is not only nonflammable, but was widely used for many years as a fire extinguishing agent in spite of its rather high toxicity. Carbon tetrabromide (CBr_4) and carbon tetraiodide (CI_4) are solids which decompose easily under heat. Generally, the presence of fluorine in the compound increases its inertness and stability; the presence of other halogens, particularly bromine, increases the fire extinguishing effectiveness of the compound. Although a very large number of halogenated compounds exist, only the following five have been used to a significant extent as fire extinguishing agents:

Halon 1011, bromochloromethane, CH_2BrCl

Halon 1211, bromochlorodifluoromethane, CBrClF_2

Halon 1202, dibromodifluoromethane, CBr_2F_2

Halon 1301, bromotrifluoromethane, CBrF_3

Halon 2402, dibromotetrafluoroethane, $\text{CBrF}_2\text{CBrF}_2$ "

TABLE 8 FLAMMABLE LIQUID FIRE TEST,
PAN SIZE, MATERIALS, AND ARRANGEMENT

Rating - Class	Minimum Effective Discharge Time, Seconds	Pan Size, (Inside)		Metal Thickness,		Reinforcing Angle Size,		n-Heptane Used, (Approximate)	
		Square Feet	m ²	Inch	mm	Inches	mm	U.S. Gallons	L(dm ³)
Indoor tests:									
1-B	8	2-1/2	0.25	1/4	6.4	1-1/2 by 1-1/2 by 3/16	38.1 by 38.1 by 4.8	3-1/4	12.5
2-B	8	5	0.45	1/4	6.4	1-1/2 by 1-1/2 by 3/16	38.1 by 38.1 by 4.8	6-1/4	23.5
5-B	8	12-1/2	1.15	1/4	6.4	1-1/2 by 1-1/2 by 3/16	38.1 by 38.1 by 4.8	15-1/2	58.5
10-B	8	25	2.30	1/4	6.4	1-1/2 by 1-1/2 by 3/16	38.1 by 38.1 by 4.8	31	117.0
20-B	8	50	4.65	1/4	6.4	1-1/2 by 1-1/2 by 3/16	38.1 by 38.1 by 4.8	65	245.0

(from: UL711, Rating and Fire Testing of Fire Extinguishers)

"The Halon system for naming halogenated hydrocarbons was devised by the U.S. Army Corps of Engineers to provide a convenient and quick means of reference to candidate fire extinguishing agents. The first digit in the number represents the number of carbon atoms in the compound molecule; the second digit, the number of fluorine atoms; the third digit, the number of chlorine atoms; the fourth digit, the number of bromine atoms; and the fifth digit, the number of iodine atoms. Terminal zeros are dropped. Valence requirements not accounted for are assumed to be hydrogen atoms (number of hydrogen atoms = 1st digit times 2, plus 2, minus the sum of the remaining digits)."

From NFPA 12A is this additional information about Halon 1301.

"Halon 1301 chemically is bromotrifluoromethane, CBrF_3 . Its cumbersome chemical name is often shortened to "bromotri" or even further³ to "BT." The compound is used as a low-temperature refrigerant and as a cryogenic fluid, as well as a fire extinguishing agent."

"Under normal conditions, Halon 1301 is colorless, odorless gas with a density approximately 5 times that of air. It can be liquefied upon compression for convenient shipping and storage. Unlike carbon dioxide, Halon 1301 cannot be solidified at temperatures above -270°F ($-167-8^\circ\text{C}$)."

"As the temperature is increased, the vapor pressure and vapor density decreases, until the critical temperature of 152.6°F (67°C) is reached. At this point the densities of the liquid and vapor phases become equal and the liquid phase ceases to exist. Above the critical temperature, the material behaves as a gas, but it can no longer be liquefied at any pressure."

"Halon 1301 is an effective fire extinguishing agent that can be used on many types of fires. It is effective in extinguishing surface fires, such as flammable liquids, and on most solid combustible materials except for a few active metals and metal hydrides, and materials which contain their own oxidizer, such as cellulose nitrate, gunpowder, etc."

"The mechanism by which Halon 1301 extinguishes fires is not thoroughly known; neither is the combustion process of the fire itself. It appears, however, to be a physiochemical inhibition of the combustion reaction. Halon 1301 has also been referred to as a "chain breaking" agent, meaning that it acts to break the chain reaction of the combustion process."

Table 9, also from NFPA 12A, delineates the physical properties of Halon 1301.

From NFPA 12B is this additional information about Halon 1211.

"Halon 1211 is bromochlorodifluoromethane, CBrClF_2 . It is sometimes known as BCF."

"Under normal conditions, Halon 1211 is a colorless gas with a faintly sweet smell and having a density about 5 times that of air. It can be readily liquefied by compression for storage in closed vessels."

"Halon 1211 is particularly effective against flammable liquid fires, but also has a very good performance against most solid combustible materials, and is safe against fires involving electrical equipment. It should not be used on fires of active

TABLE 9 PHYSICAL PROPERTIES OF HALON 1301

Molecular weight	148.93
Boiling point at 1 atm.	-71.95°F
Freezing point	-270°F
Critical temperature	152.6°F
Critical pressure	575 psia
Critical volume	0.0215 ft ³ /lb
Critical density	46.5 lb/ft ³
Specific heat, liquid, at 77°F (25°C)	0.208 BTU/lb-°F
Specific heat, vapor, at constant pressure (1 atm.) and 77°F (25°C)	0.112 BTU/lb-°F
Heat of vaporization at boiling point	51.08 BTU/lb
Thermal conductivity of liquid at 77°F (25°C)	0.024 BTU/hr-ft-°F
Viscosity, liquid, at 77°F (25°C)	1.01 × 10 ⁻⁴ lb-ft-sec
Viscosity, vapor, at 77°F (25°C)	1.08 × 10 ⁻⁵ lb-ft-sec
Surface tension at 77°F (25°C)	4 Dynes/cm
Refractive index of liquid at 77°F (25°C)	1.238
Relative dielectric strength at 1 atm., 77°F (25°C) (nitrogen = 1.00)	1.83
Solubility of Halon 1301 in water at 1 atm., 77°F (25°C)	0.03% by wt
Solubility of water in Halon 1301 at 70°F (21°C)	0.0095% by wt

(from: NFPA 12A, Halon 1301 Fire Extinguishing Systems)

active metals and metal hydrides, nor against burning materials that contain their own oxidizer. Although its boiling point is 26°F (-4°C), it is capable of being discharged from a hand extinguisher as a liquid jet with an effective throw."

"The extinguishing action of most common agents is through the physical processes of cooling and diluting. The chemical extinguishants are much more effective because of their ability to interfere with the combustion processes. They act by removing active species that are involved in the chain reactions: a process known as chain breaking. All the halogens are active in this way, but bromine is very much more effective than either chlorine or fluorine, and it is probable that Halon 1211 owes its high efficiency mainly to the presence of a bromine atom in the molecule."

Table 10, from NFPA 12B, delineates the physical properties of Halon 1211.

From NFPA 17, Dry Chemical Extinguishing Systems is the following general information.

"A dry chemical extinguishing agent is a finely divided powdered material that has been specially treated to be water repellent and capable of being fluidized and free-flowing so that it may be discharged through hose lines and piping when under expellent gas pressure. Dry chemicals currently in use may be described briefly as follows:

1. Sodium Bicarbonate (NaHCO_3) Based Dry Chemical

This agent consists primarily of sodium bicarbonate and is suitable for use on all types of flammable liquid and gas fires (Class B) and also for fires involving energized electrical equipment (Class C).

Its effect on fires in common cooking oils and fats is particularly good, as in combination with these materials the sodium bicarbonate based agent reacts to form a type of soap (saponification), which floats on the liquid surface such as in deep fat fryers and effectively prevents reignition of the grease.

Sodium bicarbonate base dry chemical is not generally recommended for the extinguishment of fires in ordinary combustibles (Class A), although it may have a transitory effect in extinguishing surface flaming of such materials.

2. Dry Chemicals Based on the Salts of Potassium

Commercially available agents are essentially potassium bicarbonate (KHCO_3), potassium bicarbonate ($\text{KC}_2\text{N}_2\text{H}_3\text{O}_3$). All three agents are suitable for use on all types of flammable liquid and gas fires (Class B) and also for fires involving energized electrical equipment (Class C).

It is generally recognized that salts of potassium are more effective in terms of chemical extinguishment mechanisms than sodium salts in extinguishing Class B fires except those in deep fat fryers and other cooking equipment.

Dry chemicals based on the salts of potassium are not generally recommended for the extinguishment of fires in ordinary combustibles (Class A), although they may have a transitory effect in extinguishing surface flaming of such materials.

TABLE 10 PHYSICAL PROPERTIES OF HALON 1211

Molecular Weight	165.58
Boiling Point at 1 atm., °F	26.0
Boiling Point at 1 atm., °C	-3.4
Freezing Point, °F	-256.0
Freezing Point, °C	-160.5
Critical Temperature, °F	309.0
Critical Temperature, °C	153.8
Critical Pressure, psia	595.4
Critical Pressure, bars	42.06
Critical Pressure, atm.	38.7
Critical Volume, cu. ft./lb.	0.0225
Critical Volume, m ³ /kg	0.00141
Critical Density, lb./cu. ft.	44.5
Critical Density, kg/m ³	713.0
Specific Heat, Vapor, 1 atm., 77°F, BTU/lb./°F	0.108
Specific Heat, Vapor, 1 atm., 25°C, kJ/kg/°C	0.452
Specific Heat, Liquid @ 77°F, BTU/lb./°F	0.185
Specific Heat, Liquid @ 25°C, kJ/kg/°C	0.775
Heat of Vaporization at BPt, BTU/lb.	57.0
Heat of Vaporization at BPt, kJ/kg	132.6
Heat of Vaporization at BPt, cal/g	32.0
Molar Heat Capacity, cal/g/mol/°C	30.5
Liquid Viscosity @ 77°F (25°C), centipoise	0.34
Vapor Viscosity @ 77°F (25°C), centipoise	0.013
Surface Tension @ 77°F (25°C), dyne/cm	16.5

(from: NFPA 12B, Halon 1211 Fire Extinguishing Systems)

3. Multipurpose Dry Chemicals

This agent has as its base monoammonium phosphate ($\text{NH}_4\text{H}_2\text{PO}_4$) and is similar in its effect on Class B and Class C fires to the other dry chemicals. However, it does not possess a saponification characteristic and should therefore not be used on deep fat fryers. Unlike the other dry chemicals it does have a considerable extinguishing effect on Class A materials. The agent, when heated, decomposes to form a molten residue which will adhere to heated surfaces. On combustible solid surfaces (Class A) this characteristic excludes the oxygen necessary for propagation of the fire.

The detailed mechanisms by which dry chemical agents extinguish fires have not been completely determined. However, it is generally accepted that the Primary Extinguishing Mechanisms include interruption of the chain reaction sequence by chemical reactions, reduction of liquid fuel evaporation rates by reduction in flame radiation at the liquid surface, and inerting effects due to reduction of oxygen concentration within the active fire zone. Secondary Extinguishing Mechanisms may include heat absorption effects (particularly at high dry chemical concentrations), additional cooling effects due to the formation of water vapor by the pyrolysis processes, additional inerting effects due to the formation of carbon dioxide by the pyrolysis of the dry chemical, and fire retardant effect due to surface coatings."

Of the extinguishing agents used in this country for hand portable fire extinguishers, water is suitable solely for Class A fires, while Halon 1211, CO_2 , and Dry Chemical are suitable for Class A, B, and C fires. Halon 1301 is suitable for Class B and C fires. While having the greatest pound for pound fire fighting capability of any of the agents, Dry Chemicals generally are rated poorly with respect to visibility in confined spaces, corrosion potential and around-object capability which make them poorly suited for aircraft application. In addition, dry chemicals present the greatest cleanup task of the Class B fire extinguishants. Gaseous agents (Halons, CO_2) generally have superior around-object capability. Of the Class B fire extinguishants, Halon 1211 and Dry Chemical have the greatest range potential. Table 11 presents a comparative summary of basic characteristics for Halon 1211, Halon 1301, ABC Dry Chemical, CO_2 and Water.

It should be recognized that, when used in hand-held extinguishers, certain characteristics will vary depending upon the specific manufacturer and model. For instance, effective range of an extinguisher for a particular agent is dependent upon the orifice size, nozzle arrangement, and agent capacity. Filled unit weight will also vary greatly by manufacturer and model for equivalently rated extinguishers of the same agent, due to cylinder and valve construction materials. This variable is, of course, significant for aircraft application because of drastic increases in fuel costs. As indicated in the table, a 5BC rated Halon 1211 extinguisher may be obtained at approximately one third the weight (agent plus extinguisher) of the smallest equivalently rated CO_2 extinguisher. In contrast, twice the BC rating of Halon 1211 may be obtained at slightly more weight (agent plus extinguisher) with multipurpose dry chemical. It is important, however, not to lose sight of the results from the FAA Technical Center tests (reference 11) on liquid fuel-soaked aircraft seat fires discussed previously.

TABLE 11. EXTINGUISHING AGENT BASIC CHARACTERISTICS

Agent	Minimum Agent Weight Necessary For 10 BC Rating (pounds)	Minimum Agent Weight Necessary For 1A Rating (pounds)	Agent plus Extinguisher For 5 BC Rating (pounds)	Around Object Capability	Corrosion Potential	Visibility in Confined Space	Nominal Range (feet)	U.L. Toxicity Group
Halon 1211	5	9	4-6.5	Good	No	Good	9-15	5
Halon 1301	13	Not Applicable	No units commercially available	Good	No	Good	4-6	6
Dry Chem (ABC)	2.5	2.5	5-10*	Poor	Yes	Poor	5-12	Non-toxic
CO ₂	10	Not applicable	12-20	Fair	No	Good	3-8	5
Water	Not applicable	10.4	Not applicable	Poor	Not applicable	Good	30-40	Non-toxic

* 10 BC Rating

In addition, with respect to costs, wide variations exist in purchase and recharge prices. For reference, Table 12 provides a comparative display. Variations in costs result from differences in make and model, distributor margin, and quantity purchased. It is easy to see how such variations exist when it is recognized, for instance, that 5BC rated Halon 1211 extinguishers are available from 15 different manufacturers.

One significant point relating to maintenance and reliability should be cited relative to pressurized extinguishers, since misconceptions were noted during field visits. Underwriters' Laboratories requires a gage for such units. The gage provides the status of the pressurizing medium, and not the status of agent fill volume. Again, by way of example, it is possible to discharge as much as 75 percent of the Halon 1211 from a 2 1/2-pound hand-held extinguisher while the pressure gage remains in the safe region. Accurate evaluations of agent content are obtained only through weighing.

DISSIPATION OF HALON CONCENTRATION.

Aircraft certificated under FAR Part 121 (Air Carrier) are pressurized (ventilated). Small general aviation aircraft are most likely not pressurized although air change rates due to natural ventilation are comparable. Intermediate-size aircraft could be either pressurized or unpressurized. Since the discharge of halogenated hydrocarbon extinguishants (1211 or 1301) in an aircraft cabin or cockpit could result in concentrations considered hazardous (depending of course on the volume discharged and the volume of the enclosure), dissipation or concentration versus time for various conditions must be reviewed.

One relevant study (reference 15) conducted in December of 1980 was sponsored by the U.S. Coast Guard "to determine airborne levels, exposures and dissipation of Halon 1211..." The study was funded since Halon 1211 is being considered for use on Coast Guard aircraft. Discharges were performed in a C-130 aircraft (on the ramp) manned with personnel at key locations. "To simulate a major electrical fire onboard the craft, three extinguishers (5 pounds each) of Halon 1211 were utilized in sequence requiring approximately a minute's time. This was done with the plane pressurized as in flight conditions. Normal flight procedures call for opening the cockpit hatch and the side doors in the rear cargo area to clear smoke and fumes after the fire is controlled. This procedure was followed in the simulated ground testing except that the aircraft was facing into a 25-30 knot wind. Flight conditions would have wind conditions of 6-8 times that velocity. Air turnover rate in the craft would accordingly be accelerated. Therefore, the Halon and smoke levels would dissipate much more quickly in all sections of the aircraft than indicated by the test data."

Three tests were conducted. "The first test, with three 5-pound extinguishers discharged sequentially, was performed in the forward section of the cargo area, immediately behind the cockpit. One crewman, in the cockpit, opened the forward hatch per the fire training standard operating procedure. The second crewman, stationed in the forward section, assisted in firing the extinguishers. The third crewman, stationed in the rear cargo section, opened the side cargo doors as required. The second extinguisher was discharged in the cockpit, and the third test simulation was done in the rear cargo section of the aircraft, following the procedures previously outlined."

The following results and conclusions were obtained. "Air concentrations and exposures, as anticipated, were highest when using the extinguisher in the cockpit because of its limited size and air volume. Air turnover rates in the forward section of the cockpit are also lower. Even in the confined area of the cockpit, the average exposure

TABLE 12. COMPARATIVE EXTINGUISHER COSTS

	Purchase Cost (\$)	Recharge Cost (\$)
5BC Halon 1211 (2 1/2 lb)	25-45	15-20
Halon 1301	Not commercially available*	Not available
5BC CO ₂ (5 lb)	40-75	7-11
1A-10BC Dry Chemical (2 1/2 lb)	9-20	4-7
Aircraft Water (Kidde) (1 1/3 quarts)	335	Nominal (CO ₂ cartridge and small amount of antifreeze)

* Although not now available, in past periods of availability, cost was approximately 3 times that of comparable 3 lb (nominal) Halon 1211 unit.

concentrations for the first 4-5 minutes were less than 3000 parts per million. When the extinguishers were used in the forward compartment area; again, the cockpit personnel are most affected. Even with the limited air turnover in the craft while on the ground, the maximum time required for total Halon disappearance was 41 minutes. In-flight clearance time, after opening the overhead cockpit hatch and rear cargo doors, would be significantly less, by virtue of the tenfold increase in wind velocity throughout the aircraft."

"None of the five participants in the exercise had any adverse effects from exposure, either acute or cumulative. Specifically, no eye or respiratory irritation, headaches, giddiness, or lack of coordination occurred. The Halon is detectable by odor for a maximum of 1-2 minutes after use. The odor, however, was not objectionable even at the highest concentrations in the cockpit. The data suggest there should not be direct acute or other effects on the flight personnel from the use of Halon 1211 on-board the C-130 aircraft."

Figure 8 depicts concentration-time curves for the cockpit test. It should be recognized that the concentrations were determined on the basis of personally worn sampling pumps in which sampling tubes were changed at various intervals with several minutes between changes. Consequently, measurements represent average concentrations and it is not possible from the data to determine peak levels in the first few minutes following discharge.

Another investigation of significance was carried out by ICI (reference 16), manufacturers of Halon 1211, (BCF or Bromochlorodifluoromethane) in which a series of experiments were performed to measure concentration-time data resulting from discharge of hand-held extinguishers in confined spaces. Three volumes "were selected as being representative of a wide range of practical fire applications:

1. A partly ventilated room of 2,500 ft³ (71 m³) in volume.
2. A well sealed room of 945 ft³ (27 m³) in volume.
3. A cab of an Austin diesel truck, estimated volume 97 ft³ (2.7 m³).

In several of the experiments a nominal 3-pound (1.4 kilogram) 'BCF' hand extinguisher was used and in most instances this would represent, in practical terms, an excessive use of 'BCF' in the smaller volumes. Additional tests using about 8 pound (3.6 kilogram) of 'BCF' were carried out in the partly ventilated room."

The following discussion and conclusions were made: "The results show that the highest concentration of 'BCF' always occurs at floor level and the lowest concentration at ceiling height. The latter corresponds closely to nose height in the case of the cab.

The results obtained in the well sealed room 945 ft³ (27 m³) demonstrate the 'layering' effect when hand extinguishers are discharged. This effect is not observed in 'total flood' systems where the energy at discharge is considerably greater and the consequent atmospheric turbulence more pronounced than that created by the discharge of a hand extinguisher. The high vapor density of 'BCF' also contributes to this effect.

No high local concentrations of 'BCF' were recorded and, as would be expected, a small degree of ventilation caused a rapid decrease in concentration at all points."

The report includes ten time-concentration graphs of the three volumes under varying

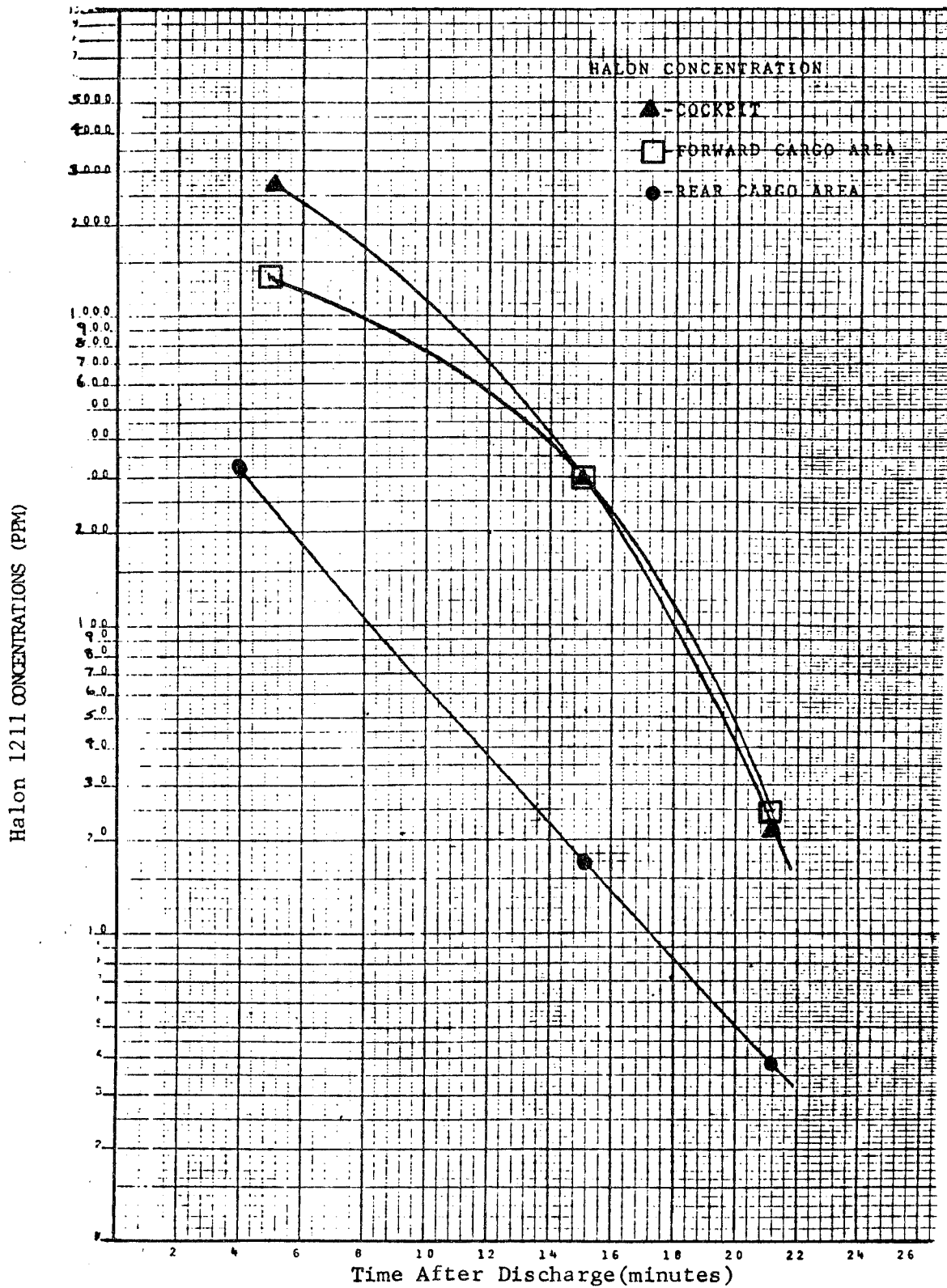

FIGURE 8 EXTINGUISHER DISCHARGE - COCKPIT AREA(reference 15)

conditions with five measuring points for each test. Clearly, the highest concentrations measured were obtained in the closed truck cab tests with floor reading significantly higher than at nose height. Figure 9 presents these data. In all other tests, the highest measured concentration immediately following discharge was under 1.5 percent. Let us compare the data from this test with the figures calculated by the Air Force (reference 13), i.e., a maximum concentration of 2.1 percent per pound of Halon 1211 for 100 ft³. The Air Force figure would indicate a maximum concentration of 6.3 percent for a 3-pound discharge, since the truck cab is approximately 100 ft³. If the nose and floor readings from the closed truck cab test are arithmetically averaged at zero time from discharge, 5 percent is obtained which is reasonably consistent.

In those Air Force tests quart and 3-gallon Halon 1211 and Halon 1301 extinguishers were discharged into 210 ft³ and 814 ft³ enclosures. All combinations of extinguisher size and enclosure size were tested with no ventilation and with one air change per minute. Time-concentration data are presented in a series of graphs. Figures 10 and 11 are representative of the data.

Time-concentration evaluations were also conducted specifically for Halon 1301 in at least two directly relevant nonfire environments. One study was the U.S. Army AH-1 Helicopter program referenced previously (reference 14). In this study, the cabin of the helicopter was considered a totally flooded ventilated area. Flow rates ranging between 1.2 and 3.3 cubic feet per second (which represent a realistic spread under various normal ventilation modes) were used in a formula obtained from the 1971-1972 NFPA Fire Codes to calculate time concentration curves resulting from a 3 1/4 pound Halon 1301 extinguisher discharge in the 45-ft³ cabin. Discharge times of both 17 seconds and 27 seconds were assumed. Numerous calculations were made and graphs presented with the net result that concentrations greater than 15 percent for 30 seconds or 6 percent for 60 seconds from start of discharge were possible only with ventilation rates less than 1.0 cubic feet per second.

Specifically among the conclusions were: (1) "With a ventilation rate between 1.2 and 3.3 cubic feet per second and 100 percent extinguisher discharge in 16 seconds, no crew member will receive an overexposure to Halon 1301". (2) For a 27 second discharge duration and ventilation rates of 1.2 cubic feet per second or more, "there is no danger of overexposure of Halon 1301. When the ventilation rate is at 0.8 cubic feet per second there is not sufficient flow to remove the Halon 1301 to the acceptable limit within 60 seconds, therefore, low flow rates are not recommended." (3) For three 2-second discharges with 5-second separations and a ventilation rate of 1.0 cubic feet per second or greater "the concentration obtained in the cabin would not cause any danger to the crew." (4) When smoke is detected in the cockpit, "The standard procedure is to cut the main circuit breaker for all electrical power and slow the helicopter to 40 knots (46 miles per hour), then open both the pilot's and copilot's doors and proceed until the smoke is cleared. If the extinguisher was discharged at this time the concentration would be far below any level of danger. What could be considered as an added safety factor is the fact that Halon 1301 is five times heavier than air. Any agent concentration that wasn't removed by the large quantity of air flowing through the cockpit would remain at the lower portion of the cabin out of the breathing zone of the crew." (5) "An assumption that was made before the agent concentration could be calculated was that the cockpit be considered a totally flooded area. For the cockpit to actually be a totally flooded area there would need to be multiple discharge points for the extinguishant. Since the AH-1 has only one extinguisher, the cockpit would not be a totally flooded enclosure in the strictest sense. Therefore, all values of extinguisher agent concentration presented in the graphs are higher than those values that would actually be received."

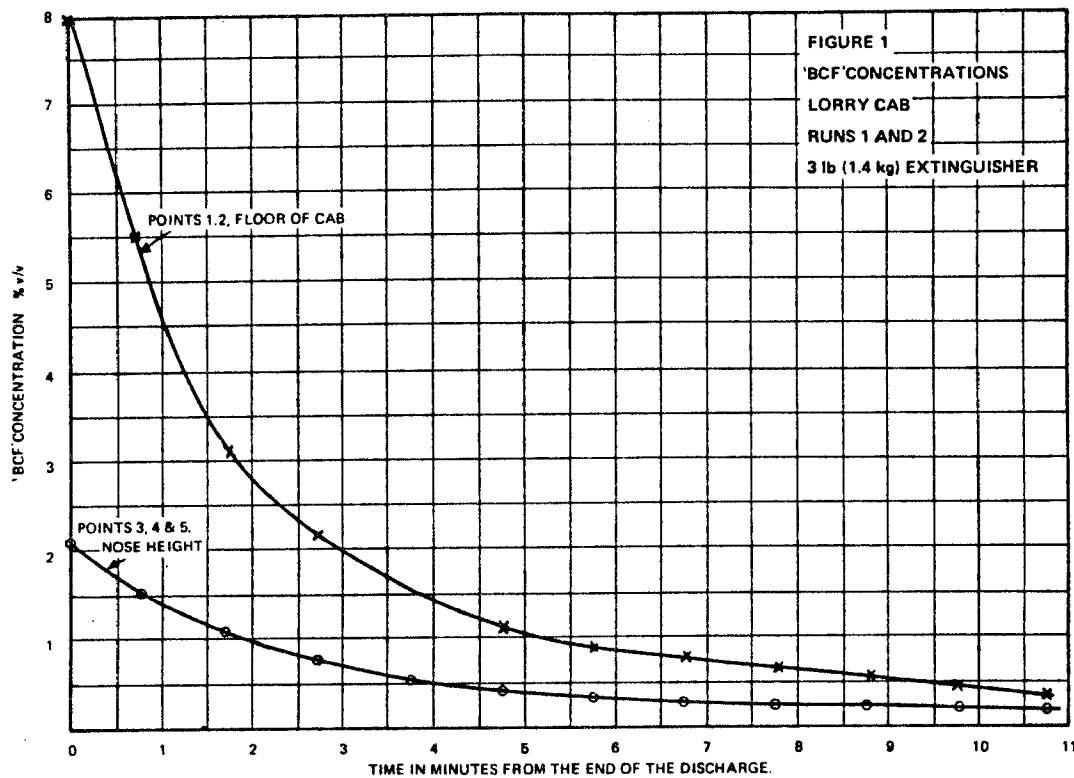

FIGURE 9 'BCF' CONCENTRATIONS - LORRY CAB, RUNS 1 AND 2
 3-lb(1.4 kg) Extinguisher (reference 16)

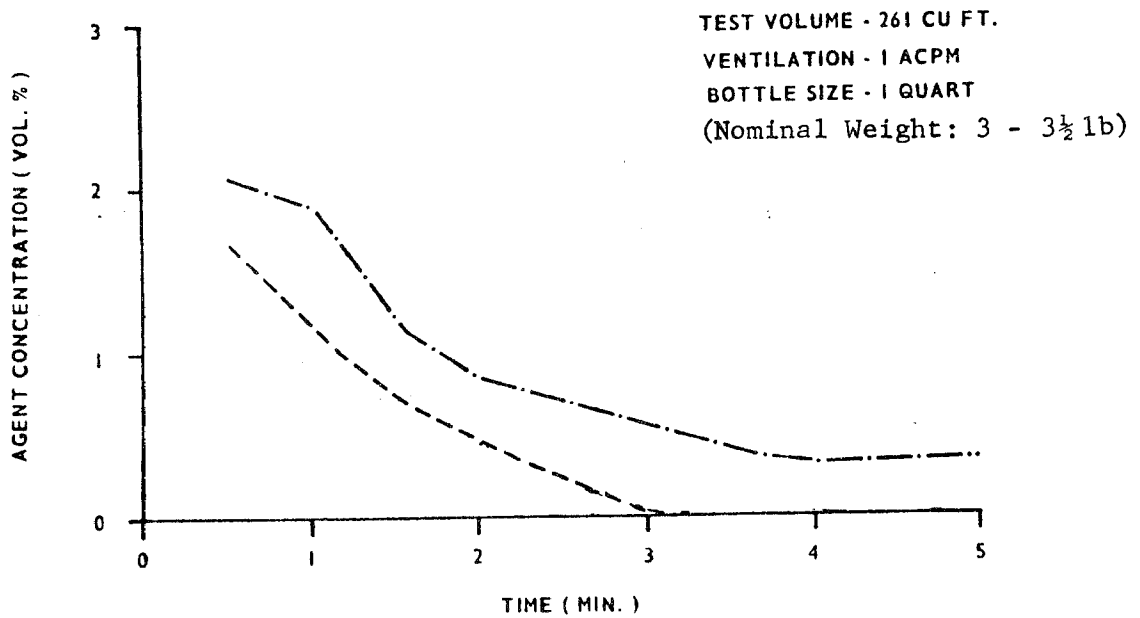
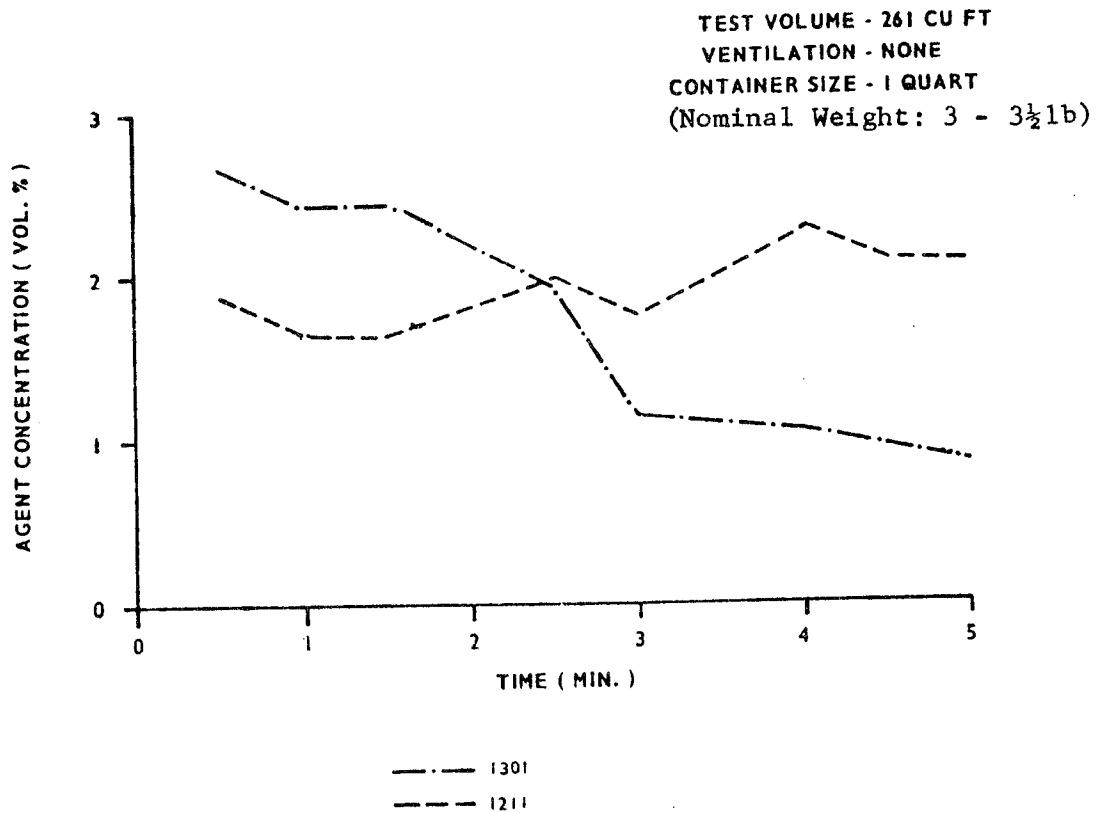

FIGURE 10 AGENT CONCENTRATION IN SMALL VOLUME USING 1-QUART EXTINGUISHERS (reference 13)

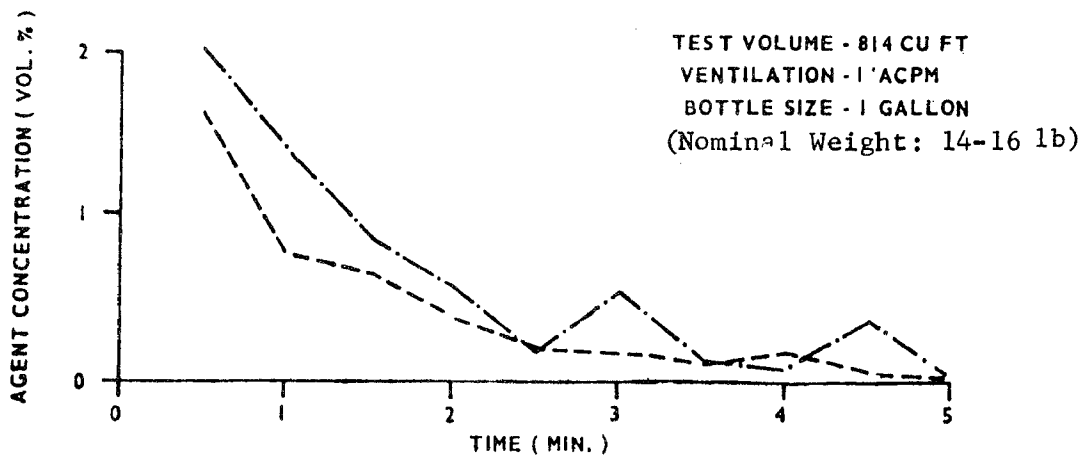
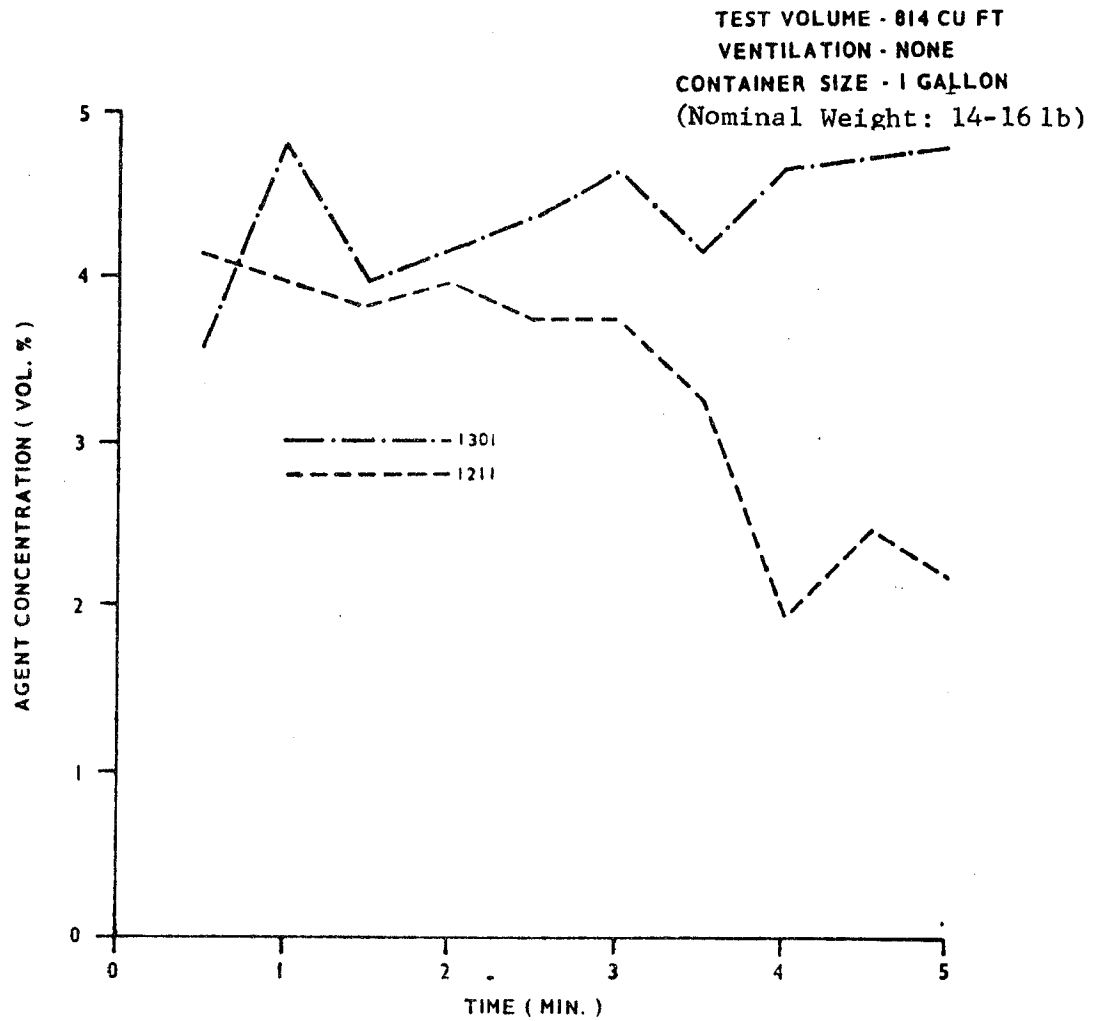

FIGURE 11 AGENT CONCENTRATION IN LARGE VOLUME USING 1-GALLON EXTINGUISHERS (reference 13)

Extensive time-concentration work has been performed by ENK Aviation Corporation, a designer and manufacturer of "custom designed" Halon 1301 systems for general aviation aircraft. ENK Aviation has conducted numerous in-flight tests in pressurized and nonpressurized compartments in which gas samples are taken in several locations. Aircraft in which tests have been performed include a substantial range of aircraft size up to a DC-3. Specific information from the tests is proprietary, since the results represent work pioneered by the company beginning in 1975. However, the author was supplied with test data (reference 17) which clearly show that such systems can be designed within strict parameter specifications. Understanding and quantifying air movement is essential.

In summary, it is evident that gaseous concentrations in confined spaces are dependent upon specific characteristics of and location within, the enclosure. It is important to recognize that the relationship of concentrations to time under actual conditions must meet two specific criteria: 1) adequacy for flame extinguishment; and 2) limitation to acceptable safe toxicity levels. Effective concentrations for flame extinguishment of surface fires and fires in solid materials with Halon 1211 and Halon 1301 are roughly equivalent and are presented and discussed (with supporting references) in appropriate NFPA Standards (references 18 and 19).

TOXICITY OF HALONS.

INTRODUCTION. Water and dry chemical are considered non-toxic. CO₂ has an Underwriters' Laboratories Toxicity Group rating equivalent to that of Halon 1211. However, to be an effective Class B fire suppressing agent, the required CO₂ concentration may be lethal. Nevertheless, CO₂ has been used and accepted as a fire extinguishing agent for many years. Halons are, relative to CO₂, new extinguishing agents which were generally introduced during an era of increased consumer safety awareness. The issue of "Halon" toxicity has primarily been one of apprehension and lack of information. However, if Halon 1211 and/or Halon 1301 are to be considered for habitable aircraft cabin environments, the issue must be faced. Halon toxicity is in reality comprised of two distinct parts which should be addressed individually: the neat or undecomposed state and the decomposed state. The following discussion is limited to the realistic Halon candidates for aircraft application, 1211 and 1301.

A considerable amount of work dealing with Halon toxicity has been performed in the United States over the last 30 years. Work includes mostly animal and some human evaluation. This work includes largely neat state evaluations, but certainly pyrolysis product research has also been conducted. Even for the medically trained, the total available data are very difficult to evaluate and compare, especially for the decomposed agent work. Perhaps the most definite point is the lack of preciseness of the state-of-the-art of inhalation toxicology. Very often the analytical chemists do not agree on experimental protocol. Universally accepted definitions for basic measures such as incapacitation still do not exist. Compounding the difficulty of analysis is definition of the complex relationships which may exist as the "subject" is changed from mouse to rat to cat, dog, primate, and human. Effects of some gases may vary as simply as a function of body weight. Effects of other gases such as acid gases may follow far different relationships as subject type and size are varied. Will a human's cardio-respiratory responses be similar to those experienced by a rat? In addition, strictly within the human response category, it is clear that wide variations will exist based upon subject age, general health, and many other variables. Synergistic effects are even further from complete understanding. Even more pertinent may be the "real" hazard

of particular thermal decomposition products in the light of the probable generation of toxic levels of CO for aircraft fires not extinguished rapidly. Measurements on nontraumatic fatalities of in-flight (Varig) and post-crash incidents indicate carboxy hemoglobin levels above lethal levels in a high percentage of cases. Did the victims die from CO or, in fact, were lethal levels of other toxic gases also inhaled? It is not the intent to paint a bleak picture of hopelessness but rather to make it clear that precise measures of hazard or toxicity are not currently attainable. However, various measures or yardsticks have been used to define quantitative and relative values for toxicity. One relative classification often referred to today although no longer used by Underwriters' Laboratories is their "Classification of Comparative Life Hazards of Various Fire Extinguishing Agents" based upon 1955 guinea pig exposures. Other more quantitative measures of toxicity include Approximate Lethal Concentration (ALC) at some defined exposure time, Threshold Limit Value (TLV) and Emergency Exposure Limit (EEL). Approximate lethal concentration is the concentration which will just result in no fatalities after the defined exposure time (usually 15 minutes). Threshold Limit Value is defined as the concentration to which humans may be continuously exposed for an 8 hour working day and a 40 hour working week. Emergency Exposure Limit is defined as the concentration for which a single brief accidental exposure may be tolerated without permanent toxic effects.

In addition to specific references to follow, various summary papers with excellent early work references may be reviewed in the Proceedings of the 1972 National Academy of Sciences Halon Symposium (reference 20).

NEAT STATE. It is clear from the literature that the principal toxicological effects of the agents are on the central nervous system and the heart. Central nervous system depression (anesthetic effect) ranges from light-headedness to convulsions and unconsciousness. Effects on the heart vary from mild change in blood pressure and heart rate to severe cardiac arrhythmias which can be fatal.

Halon 1301. Underwriters' Laboratories had classified Halon 1301 in Toxicity Group 6 which is the least toxic of their groups. The generally accepted ALC value (for 15 minutes) for Halon 1301 is approximately 83 percent (references 21,22,23, and 24). Obviously, ALC values are based upon nonhuman response. For reasons mentioned previously ALC results are not directly applicable to humans. "The result for Halon 1301 is particularly anomalous when considered in relation to man. A concentration of 83 percent by volume in air would result in an oxygen concentration of about 4 percent - a condition certain to give rise to anoxia. It is known that oxygen concentrations less than about 12 percent by volume can be rapidly fatal to man. This figure would result from a Halon concentration of about 40 percent" (reference 25).

Clearly, the best data are those which pertain directly to humans. Rational evaluation must be based upon human response significantly less severe than death. Therefore, concentrations resulting in human response up to and beyond disorientation, but less than the equivalent of surgical anesthesia, are of most interest. In addition, data relating to time frames of no more than about 5 minutes are again of most interest because of the intended application of the data (cabin fire scenario). Results from 1973 Medical College of Wisconsin work (reference 26) with trained human subjects exposed to Halon 1301 concentrations of up to 6 percent for 5 minutes showed: "Two men exposed to 6 percent while slowly walking and one man exposed while sedentary at the same level felt dizzy after 2 to 4 minutes; one of them had his manual coordination slightly impaired. No other effects from any of the exposures were found.

Results of these experiments indicate that the acute inhalation hazard of bromotrifluoromethane is low and that exposures similar to those conducted should be without any serious consequences."

A later (1978) work (reference 27) by the same group shows somewhat comparable human tolerance. "Three healthy male volunteers were exposed to Halon 1301 in a controlled-environment chamber for the purpose of monitoring their physiological and subjective responses to a series of Halon 1301 gas concentrations ranging from 1000 parts per million to 7.1 percent for periods of 30 minutes. The first untoward responses were observed to occur during exposures to 4.3 percent and 4.5 percent. These consisted of a sensation of light-headedness and dizziness accompanied by a feeling of euphoria occurring within 2 minutes of exposure. Exposure to 4.5 percent for 10 minutes resulted in an impairment in tests of balance in one of the three subjects. A second subject evidenced mild impairment when exposed for an additional 20 minutes. Exposure to 7.1 percent produced mild changes in tests of balance in one individual and severe impairment in a second subject who concomitantly experienced a decrement in eye-hand coordination. In the well-lighted environmental chamber all subjects demonstrated their ability to safely exit over a 1-minute period from the contaminated zone. No untoward cardiovascular responses were observed. The untoward physiological and subjective responses observed were short-lived following cessation of exposure."

The 5-minute Emergency Exposure Limit (EEL) as stated by Botteri et al (reference 28) and referenced in the Army AH-1 helicopter study (reference 14) is 6 percent. In a widely referenced 1974 review by Van Stee (reference 29) (who, with Aerospace Medical Research Laboratory co-workers, published a series of extensive related works) a 7 percent concentration limit is stated for a 3-5 minute exposure with little or no effect. A 5 percent concentration limit is stated for a 20-minute exposure with little or no effect. Human exposure data of Hine (reference 30) and Call (reference 31) were used in his analysis. Call's work was actually conducted at hypobaric conditions and concluded that "exposure to CBrF_3 under reduced atmospheric pressures is no more harmful than similar exposures at sea level. Therefore, Halon 1301 may be a safe fire suppressant for use in occupied cabin sections." Clark (reference 32) found that 3-minute exposures to 6 percent, 2-minute exposures to 9 percent, and 1-minute exposures to 10 percent all produced similar responses (dizziness, paresthesia, increased heart rate). A DuPont Haskell Laboratory report (reference 33) on Halon 1301 toxicity summarizes results of various human exposure works including Clark, Hine and Call in addition to their own (Reinhardt) (reference 34).

The author believes that NFPA 12A (reference 18) 1980 fairly utilized available data in arriving at their position: "Halon 1301 total flooding systems shall not be used in concentrations greater than 10 percent in normally occupied areas. For the purposes of this standard, a "normally occupied" area is defined as an area intended for occupancy. Areas which may contain 10 percent Halon 1301 shall be evacuated immediately upon discharge of the agent. Where egress cannot be accomplished within 1 minute, Halon 1301 total flooding systems shall not be used in normally occupied areas in concentrations greater than 7 percent."

Volumetric concentrations for local application systems (such as hand-held extinguishers) are subjected to the same limitation in the Standard. It is this author's interpretation that ventilation may be used in lieu of egress, i.e., 10 percent is allowable initially if ventilation/dissipation can be accomplished in 1 minute.

Halon 1211. Halon 1211 is classified by Underwriters' Laboratories in toxicity Group 5a which is defined as gases or vapors much less toxic than Group 4 but more toxic than Group 6. Generally quoted ALC values for Halon 1211 are between 28 percent and 32 percent (references 21,24, and 35). Again, as with Halon 1301, data of most interest are those based upon human response for exposure periods up to approximately 5 minutes, although such data are more sparse for Halon 1211.

In another Medical College of Wisconsin study (reference 36) 19 humans were exposed to very low concentrations (500-2000 parts per million) for periods of 15 minutes to 1 hour with no definite toxic effects. Clark (reference 37) reported that human subjects exposed for 1 minute to a 4 percent Halon 1211 concentration exhibited marked dizziness, and paresthesia. Recovery from central nervous system and cardiac effects was evident 1-2 minutes from the end of exposure. A DuPont Haskell Laboratory report (reference 38) on Halon 1211 in a summary of animal and human exposures references both the Clark work and Von Eickstedt work (unpublished). Von Eickstedt observed that 4.1 percent concentrations of Halon 1211 produced no symptoms during 2-3 minute exposures. No alteration of the normal function of the heart and brain were detected. Van Stee, in his summary report (reference 29) states that Halon 1301 has been studied most extensively, so results of human exposures (Hine, Call) to this compound were used to establish the exposure criteria for Halon 1211 based upon a "Biological Activity Ratio." He determines a 1.2 percent concentration limit for a 3-5 minute Halon 1211 exposure with little or no effect. A 0.8 concentration limit is determined for little or no effect at a 20-minute exposure. It should be noted that, if actual computed halogenated alkane concentration figures for Halon 1211 (displayed in Table 4.13 of his report) are used to determine limits for Halon 1211 based upon Halon 1301 exposures, the concentration limits for 3-5 minute and 20-minute exposures become 1.5 percent and 1.1 percent respectively. The following definitions for little or no effect and moderate effect are from the Van Stee report:

1. Little or No Effect

"This is defined as a slightly perceptible feeling of lightheadedness with the possibility of occasional slight tingling sensations in the extremities. No cardiovascular effects, with the possible exception of a slight increase in heart rate, would be expected."

2. Moderate Effect

"This is defined as a definite feeling of lightheadedness that might be perceived by some individuals as a symptom of impending unconsciousness. Tingling sensations (paresthesia) would be expected to be felt by some. Heart rate would be expected to accelerate moderately and but few individuals would be expected to develop serious electrocardiographic abnormalities. The onset of those symptoms should alert the subject to be prepared to discontinue further exposure."

The author again believes that the NFPA Standard 12B (reference 19) 1980, paragraph A-1-6), provides acceptable guidance based upon available data:

"Undecomposed Halon 1211 has been studied in humans and found to produce minimal, if any, central nervous system effects at concentrations below four percent for exposures of approximately one minute duration. At concentrations above four percent effects such as dizziness, impaired coordination and reduced mental acuity become definite with exposure of a few minutes' duration; however, these effects are not incapacitating for exposure of one minute or less. With the first thirty

seconds of exposure to Halon 1211 little effect is noticed, even when concentrations above four percent are inhaled. At these levels this amount of time appears necessary for the body to absorb a sufficient quantity of agent to bring about the onset of effects. At concentrations of the order of five to ten percent there is the risk of unconsciousness and possible death if the exposure is prolonged."

In addition to the concentration limitation for 30 seconds and 1 minute as quoted above from NFPA 12B, the author also concludes from available data, that Halon 1211 concentrations of 1.5 percent for 3-5 minute exposures will not produce significant effects.

Comparative Summary. There is no question that pure Halon 1211 is more toxic than pure Halon 1301. Van Stee (reference 29), uses a measure of approximately 5-1 based upon a biological activity ratio. Thorn (reference 25) in his appraisal based upon a simple quantitative theory of anesthesia calculates a ratio of approximately 5 1/2 to 1. It should be noted for reference that Thorn, using the same theory, determines CO₂ to be 1 1/3 times as toxic as Halon 1211.

DECOMPOSED STATE. Both Halon 1301 and Halon 1211 decompose when exposed to flames or hot surfaces above approximately 900°F. Clearly, both agents are far more toxic in the decomposed state than in the neat state. The appendices of both NFPA 12A and 12B contain the following statements: "The decomposition products of Halon 1301 and Halon 1211 have a characteristic sharp acrid odor, even in concentrations of only a few parts per million. This characteristic provides a built-in warning system for the agent, but at the same time creates a noxious, irritating atmosphere for those who must enter the hazard following a fire."

"The amount of Halon 1301 or Halon 1211 that can be expected to decompose in extinguishing a fire depends to a large extent on the size of the fire, the concentration of Halon vapor and the length of time that the agent is in contact with flame or heated surfaces above 900°F (482°C). If there is a very rapid build-up of concentration to the critical value, then the fire will be extinguished quickly, and there will be little decomposition. The actual concentration of the decomposition products must then depend on the volume of the room in which the fire was burning, and on the degree of mixing and ventilation."

Actual human tolerances to the products of thermal decomposition of either agent are even more difficult than the pure agents to pinpoint, for the numerous reasons discussed previously. We must recognize that, for decomposition products, quantified "limit" concentrations are completely based upon animal exposures. Various studies with laboratory animals have been made through the years to quantify different threshold limits for the decomposition products of Halon 1301 and Halon 1211. Somewhat different results have been obtained depending upon experimental procedures, definitions, exact concentration versus time of exposure, etc. However, Sax's summation in his Dangerous Properties of Industrial Materials handbook, is the best information available. His data are presented in Tables 13 and 14 as reproduced from NFPA Standards 12A and 12B. Table 13 (reference 18) lists the primary decomposition products of Halon 1301 and the corresponding ALC's and dangerous concentrations where available. Table 14 (reference 19) is an analogous listing for Halon 1211. It should be recognized that, in contrast to the anesthesia effect of the pure agents, the primary hazard from acid gases is edema of the upper respiratory system causing suffocation in severe cases. Human and animal response may again be quite different at elevated exposure levels.

TABLE 13 DECOMPOSITION PRODUCTS OF HALON 1301

Compound	ALC for 15-min Exposure ppm by Volume in Air	Dangerous Concentration* ppm by Volume in Air
Hydrogen Fluoride, HF	2500	50-250
Hydrogen Bromide, HBr	4750	-
Bromine, Br ₂	550	50***
Carbonyl Fluoride, COF ₂	1500	-
Carbonyl Bromide, COBr ₂	100-150**	-

* Sax, N. Irving: Dangerous Properties of Industrial Materials; Fourth Edition; Section 12; Reinhold Publishing Corporation; New York, NY; 1975.

** Value is for carbonyl chloride, COCl₂ (phosgene); value for carbonyl bromide is not available.

*** Value is for chlorine (Cl₂); value for bromine is not available.

TABLE 14 DECOMPOSITION PRODUCTS OF HALON 1211

Compound	ALC for 15-min Exposure, ppm by Volume in Air	Dangerous Con- centration*, ppm by Volume in Air
Hydrogen Bromine (HBr)	4750	-
Hydrogen Chloride (HCl)	4750	1000 - 2000
Hydrogen Fluoride (HF)	2500	50- 250
Bromine (Br ₂)	550	50**
Chlorine (Cl ₂)	350	50
Fluorine (F ₂)	375	-
Carbonyl Bromide (COBr ₂)	100 - 150***	-
Carbonyl Chloride (COCl ₂)	100 - 150	50
Carbonyl Fluoride (COF ₂)	1500	-

* Sax, N. Irving; Dangerous Properties of Industrial Materials; Fourth Edition; Section 12; Reinhold Publishing Corporation New York, NY; 1975.

** Value for chlorine; value for bromine is not available.

*** Value for carbonyl chloride, COCl₂; value for carbonyl bromide is not available.

In any event, for valid analysis of the products of combustion hazard, particular scenarios must be evaluated, since enclosure volume, agent concentration, and flame exposure time are critical. Results from specific scenario fire testing ideally should be well below the published values for decomposition products, since: (1) values in Tables 13 and 14 are probably not exact (especially for humans); (2) wide variations exist even between human subjects; and (3) maximum measured values may not be accurate due to sampling locations and times.

For purposes of example, specific results from Halon 1211 extinguished fire tests are presented.

One program performed by the Air Force Aero Propulsion Laboratory (reference 13) (to determine a suitable replacement for Halon 1011) included discharge of Halon 1301 and Halon 1211 on Class A fires in a 814 ft³ enclosure. The fuel load was 4 pounds of absorbent cotton batting. Extinguisher size was nominally one quart. Actual discharge of 1211 and 1301 ranged from 2.80 pounds to 3.48 pounds. Tests were conducted both with no ventilation and with one air change per minute. HF and HBr were measured directly. The presence of chlorides could be detected but not measured in the presence of bromides. Levels of HCl were estimated to be approximately equal to HBr levels. In all cases the fire load continued to smolder throughout the test. Table 15 provides a summary of the 1301 and 1211 decomposition data. As can be seen, the data show higher concentrations of HBr and HF for Halon 1211 than Halon 1301 in the quiescent condition with the trend reversed with ventilation. All readings were below 13 parts per million.

A second fire test program (reference 39) is directly relevant to this analysis. It is currently under way at the FAA Technical Center. It is intended to be a realistic and in-depth evaluation of Halon 1211, dry chemical, water, and CO₂ in a volatile liquid hijacking fire scenario; in essence an extension of work² conducted in the fall of 1980. At this writing, only the Halon 1211 tests have been conducted. Since the data include relevant thermal decomposition measurements, results are included in this discussion. Two Halon 1211 simulated-wide-body tests were performed inside a C-133 with in-flight ventilation simulated at approximately one air change every 3 minutes. One quart of volatile liquid was poured on a standard triple-passenger seat and ignited. After a 10-second preburn, a remotely controlled extinguishing apparatus was used to fire the extinguisher approximately 6 feet from the seat. Laboratory rats were in the enclosure in two locations within 10 feet from the seats. The Halon 1211 quickly knocked down the flames and the fires were extinguished with a single nominal 2 1/2 pound extinguisher. Gas samples were taken at three locations: 5.5 feet above the floor directly behind the extinguisher; 5.5 feet above the floor behind the seat; and 3.5 feet above the floor behind the seat. Laboratory rats were unaffected. Peak concentrations of Halon 1211 measured were 2000 parts per million at about 30 seconds. Concentrations at that location had dropped to approximately 300 parts per million by 2 minutes. The highest concentration of Halon 1211 recorded at the two other sampling locations was approximately 500 parts per million at 1 minute. Maximum recorded concentrations of HCl, HF and HBr were 35 parts per million, 10 parts per million, and 5 parts per million respectively. Peak measurements were all taken at about 1 minute at the sampling location directly behind the extinguisher. As can be seen, maximum recorded concentrations of HCl, HF and HBr are; (1) at least two orders of magnitude below ALC's from Table 14 and (2) 1/5 and 1/30 of the dangerous concentration range minimums from Table 14 for HF and HCl respectively.

TABLE 15 DATA SUMMARY - PHASE II: PYROLYSIS DATA
 TEST VOLUME - 814 ft³
 CLASS A FIRE

		Quiescent				
Agent	Pyrolysis Product	Concentration (ppm)				
		1 min	2 min	3 min	4 min	5 min
1211	Hydrogen Fluoride	6.4	12.2	5.5	8.6	4.5
1211	Hydrogen Bromide	8.1	10.8	1.0	4.9	3.4
1301	Hydrogen Fluoride	4.1	2.1	2.1	5.3	3.2
1301	Hydrogen Bromide	0	0	0	0	0
		Ventilation (One acpm)				
1211	Hydrogen Fluoride	4.4	0.8	0.9	1.9	0.2
1211	Hydrogen Bromide	2.6	T	T	T	0
1301	Hydrogen Fluoride	7.5	2.7	2.6	0.6	1.4
1301	Hydrogen Bromide	4.1	1.5	1.7	0	1.0

Legend:

T Trace

SUMMARY.

It appears that, if the environment is examined logically with respect to extinguisher selection, it is possible to partition the universe initially into as many as four subsets: DC-9 size class and up passenger compartments; flight stations/cockpits of that size class plane; small (2-6 seats) general aviation aircraft; and intermediate-size aircraft. In terms of interior volume and mental alertness requirements, there is justification for considering cockpits and small general aviation aircraft analogous. In terms of air movement and breathing apparatus they are not equivalent. The large aircraft passenger compartments logically constitute large volumes. In addition, the potential effects of judgment impairment are not as critical. Further, ventilation (one air change per every three minutes) is generally a normal condition. The intermediate-size aircraft should be treated in essence on individual bases, sometimes falling under the recommendations for the smaller volume, sometimes under the recommendations for the larger volume, depending on exact volume, fire loads, ventilation, etc.

In considering the small-volume aircraft, the advantages (range and directionality attributed to Halon 1211 over Halon 1301 from previous Air Force studies) are not appropriate, as they are for large aircraft passenger compartments. It is therefore conceivable that the neat state margin of safety of Halon 1301 over Halon 1211 would be worth exploiting. Recall that as of this report there is not a single Factory Mutual-Approved or Underwriters' Laboratories-listed Halon 1301 hand-held fire extinguisher in the 2 1/2-3-pound range. However, it is anticipated that one will be available in the near future. It should be recognized that the discharge of a hand-held Halon extinguisher in a small volume aircraft would in effect result in a totally flooded volume.

In considering the flight deck of the large volume pressurized aircraft, the advantages of breathing apparatus, good low-level air discharge (Halons are heavier than air) resulting in rapid dissipation, and the remote threat of other than an electrical fire would make a choice of Halon 1211 over Halon 1301 acceptable if desired.

In considering the large volume passenger compartments it must be recognized that potential fire scenarios fall into two broad groups. The first is the high-frequency, low-severity fires. The other is the low-frequency, high severity "rare" or potential situation such as would result from a volatile liquid-soaked passenger seat ignition. Clearly, Halon 1211 has been shown to provide superior fire fighting capability for such a scenario. The toxicity of Halon 1211 has two distinct issues: the neat state (undecomposed), and the decomposed state. The neat state issue is in essence one of acceptable concentration (percent by volume) levels for human exposure over a nominal 3-5 minute time interval. The results of inhalation toxicity work combined with data on ventilation and dissipation rates are all pertinent in the decision-making process. It is the belief of the author that enough information exists to indicate that neat state toxicity of Halon 1211 should not be considered a problem in large-volume passenger compartments. Halon 1211 decomposes when exposed to flame or hot surfaces in the vicinity of 900°F. It is fairly well agreed that definitive concentration limits are not accurately known for short-term human exposure to the products of decomposition. However, when addressing the decomposed-state toxicity, it is necessary to put the hazard into proper perspective. To do so, the two general fire scenarios discussed previously should be considered individually.

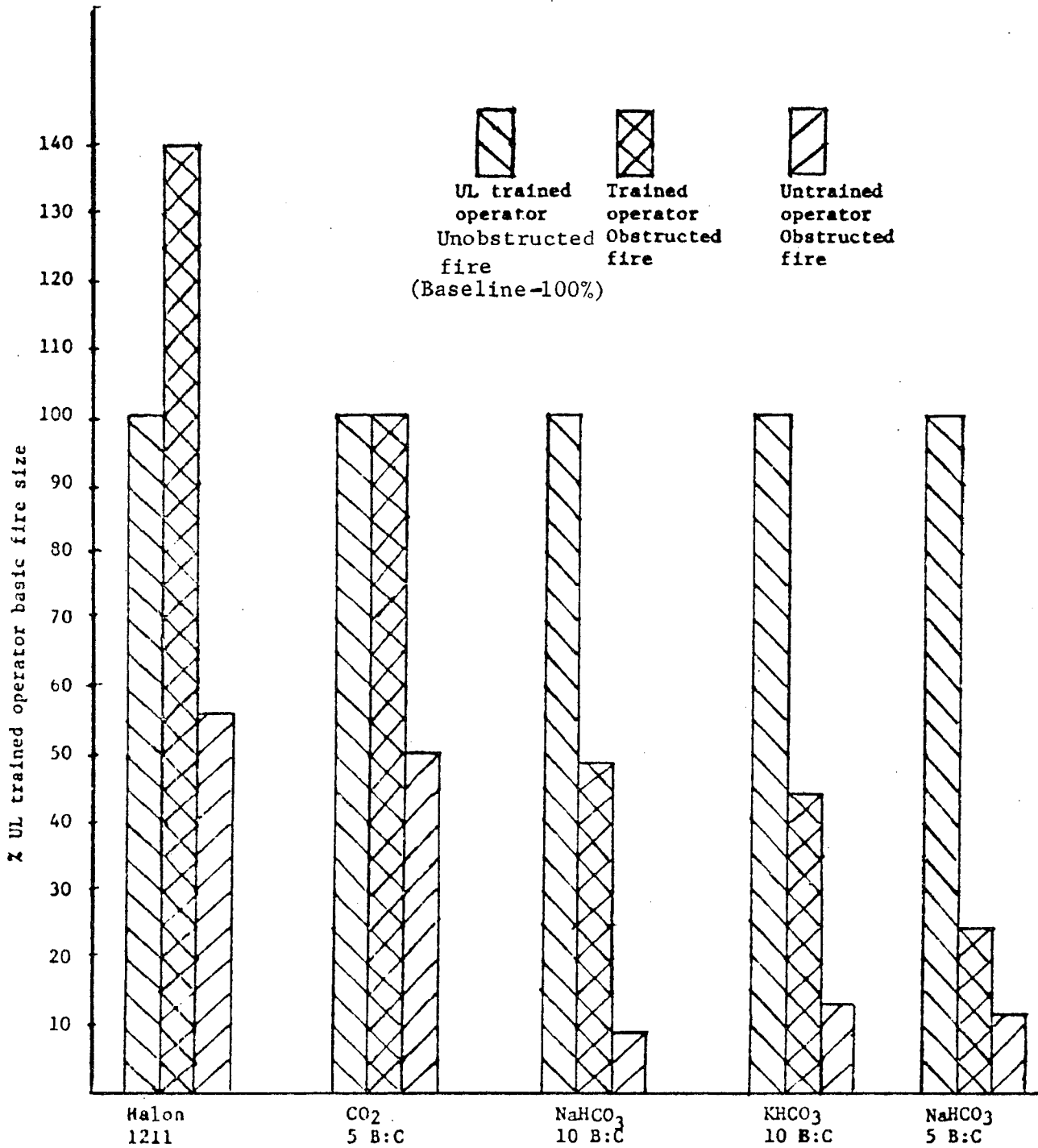

FIGURE 12 COMPARISON OF RELATIVE EXTINGUISHER OPERATOR PERFORMANCE

baseline. For example, for a 5BC CO₂ extinguisher, a trained operator was able to extinguish the same size obstructed fire as a UL trained operator was able to extinguish in an open pan. An untrained operator (with an identical extinguisher) was only able to extinguish an obstructed fire 50 percent the size of the trained operator on an obstructed fire or a UL trained operator on an open pan fire.

Although this lack of training standardization exists, it would be a matter of opinion whether there has ever been a single aircraft fire incident where lack of reasonable training resulted in a fatality.

Other pertinent items, related to training, which pertained to overall ease of operation were mentioned by several major carrier personnel responsible for flight crew training. Those comments were based upon classroom experience as well as feedback from attendants. They included:

1. Attendant difficulty in getting extinguishers out of mounting bracket due to clamp spring strength. It was indicated that during some carriers training sessions the attendants do not actually have to remove the extinguisher bottle from the mounting bracket. The extinguishers are "loose," ready for handling or discharge as the case may be. It was discovered through attendant feedback, that when situations arose calling for the dismounting of an extinguisher the attendant often had difficulty releasing the bottle as a result of the clamp tension and lack of knowing what to expect.

2. Problems with the proper operation of the Kidde water extinguisher. This extinguisher requires that the top of the unit be screwed down so that a pin can penetrate the CO₂ cartridge thus arming the extinguisher for discharge. It was reported that attendants, while trying to arm the extinguisher and experiencing the resistance of the pin against the CO₂ cartridge, have assumed they were turning in the wrong direction and reversed the direction of turn resulting in the unit separating.

3. Wide variations in design and operation of firing mechanism. It has been indicated that flight attendants may be assigned to an aircraft which has fire extinguishers utilizing a different agent or fire extinguishers using the same agent by a different manufacturer than those on board the aircraft to which they were last assigned. This potential has increased in recent years as a result of many airline mergers and the purchase of used equipment from other carriers. As can be seen from Figure 1, even the physical appearance of the discharge mechanism of various types of extinguishers may vary greatly. Actual arming and discharging procedures also vary enough such that inexperienced operators may experience difficulty. It was expressed that more standardization of design is desirable.

4. Pressurized extinguishers cannot be operated upside down. (Pressurization is discharged leaving no means for expelling the agent.) It should be recognized that each of these difficulties is compounded by the lack of adequate "hands on" experience.

One further comment relative to training relates to carriers planning to replace existing extinguishers with Halon 1211 extinguishers. It appears that such a move will result in flight attendants being on board aircraft equipped with Halon 1211 without having been through a "hands on" recurrent training. The carriers' intent

is to provide individuals with "hands on" at their next scheduled recurrent training. The carriers will rely on a written notice to all attendants in the interim to describe the extinguisher. Figure 13 is one such notice.

GENERAL AVIATION. Emergency Procedures in operating handbooks for smaller general aviation aircraft contain some guidance as to in-flight fires. (Figure 14 is typical.) However, after discussion with numerous private pilots, several points are clear: (1) few pilots have even basic hand fire extinguisher training or know the difference between different extinguisher types (unless training was obtained in the military, volunteer fire department, etc.); (2) many pilots do not check for the presence of or status of (if present) hand-held extinguishers before takeoff; (3) virtually all pilots have been taught to shut down all nonessential electrical systems and land as soon as possible at the smell of smoke. With or without the presence of a hand-held extinguisher, this advice is sound since the origin of the smoke and its accessibility by an extinguishing agent are usually unknown.

ENVIRONMENTAL TESTING.

The Air Force Engineering and Services Center at Tyndall Air Force Base has recently conducted a study (reference 41) of environmental testing and evaluation of selected commercial, off-the-shelf Halon 1211 hand portable fire extinguishers. The basic objective of the program was to determine the flightworthiness/crashworthiness of candidate extinguishers for Air Force procurement. Tests were also conducted to evaluate design features, functioning, operational capabilities and maintainability. Some of the tests deal exclusively with military requirements but most are appropriate for civilian aircraft. Extinguisher sizes tested were 10BC (5 pound agent weight), 1A10BC (9 pound agent weight), 2A40BC (14 pound agent weight), and 2A60BC/3A80BC (17 pound agent weight). In all, extinguishers from six manufacturers were involved in testing. The test samples included five extinguishers from each manufacturer in each of the aforementioned sizes which they manufactured.

Further, "Since the mounting bracket was considered to be the critical item in the extinguisher/agent/bracket combination in several of the planned tests, commercially available heavy duty aircraft/vehicular mounting brackets were included in the test sample."

Specific tests of interest on the extinguishers included; leakage, method of operation and recharging, high and low temperature versus altitude, high temperature, vibration, acceleration, and static loading. Acceleration, vibration and static loading tests were also performed on the heavy duty aircraft/vehicular mounting brackets.

In general, no extinguisher performed flawlessly. Virtually all extinguishers exhibited poor or unsatisfactory performance on at least one of the tests. Interestingly, vibration tests conducted on mounting brackets resulted in the most widespread problems. A methodology was developed which incorporated a score and weighting factor for each subtest. A score of 10, 7, 4, 1, or 0 was assigned to each test article based upon its ability to satisfy the test criteria of a particular subtest. Each subtest was then ranked relative to its importance to the overall test program and assigned a weighting index. The total value for each subtest was obtained by multiplying the score by the weighting index. The total value for each subtest was summed and averaged among the various independent scorers to obtain an informal ranking of the test articles by size and manufacturer.

HALON FIRE EXTINGUISHER

A new Halon fire extinguisher is replacing the CO₂ and dry chemical fire extinguishers. The extinguishing chemical is discharged as a semi-liquid jet and it evaporates rapidly to envelop the fire in a blanket of mist. It extinguishes the fire by interfering chemically with the combustion process. It is clean and leaves no messy residue. The Halon extinguisher is lighter in weight than the CO₂ and the agent is much more effective on fuel, grease, and electrical fires than either CO₂ or dry chemical.

When using the Halon fire extinguisher, be aware it can extinguish a flame so rapidly that the material that was burning is still hot enough to reignite. The solution to this is to make sure that the material has cooled to the extent that re-ignition cannot occur; so, keep an eye on the area till it cools.

When preflighting the extinguisher, check that the pressure gauge pointer is in the green zone and that the red ring pin is in place through the handle and lever

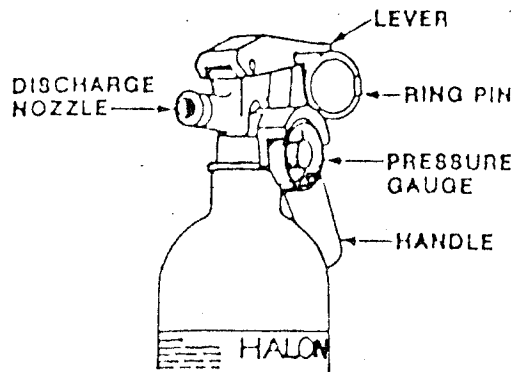

To operate the extinguisher, pull the red ring pin from its hole, hold the extinguisher upright, and aim at the base of the flame. Squeeze the handle and lever together to discharge and spray it in a sweeping motion.

Staff Vice President
Flight Operations Training

FIGURE 13 MEMORANDUM TO FLIGHT ATTENDANTS

ELECTRICAL FIRE IN FLIGHT

1. Master Switch -- OFF.
2. All Other Switches (except ignition switch) -- OFF.
3. Vents/Cabin Air/Heat -- CLOSED.
4. Fire Extinguisher -- ACTIVATE (if available).

WARNING

After discharging an extinguisher within a closed cabin, ventilate the cabin.

If fire appears out and electrical power is necessary for continuance of flight:

5. Master Switch -- ON.
6. Circuit Breakers -- CHECK for faulty circuit, do not reset.
7. Radio/Electrical Switches -- ON one at a time, with delay after each until short circuit is localized.
8. Vents/Cabin Air/Heat -- OPEN when it is ascertained that fire is completely extinguished.

CABIN FIRE

1. Master Switch -- OFF.
2. Vents/Cabin Air/Heat -- CLOSED (to avoid drafts).
3. Fire Extinguisher -- ACTIVATE (if available).

WARNING

After discharging an extinguisher within a closed cabin, ventilate the cabin.

4. Land the airplane as soon as possible to inspect for damage.

FIGURE 14 EMERGENCY FIRE PROCEDURES FOR CESSNA MODEL 152

The conclusions of the report are:

"An examination of the results of the technical test and evaluation program leads to the following conclusions:

1. The program has achieved the original goal of identifying commercially available, off-the-shelf Halon 1211 hand-portable fire extinguishers which meet flightworthiness/crashworthiness requirements for use as first-aid fire extinguishers in aircraft cabin applications.
2. The state-of-the-art in Halon 1211 fire extinguishers indicates that it is feasible to manufacture units which could substantially conform to military specifications for use onboard aircraft.
3. The military specifications developed under this program (Draft Purchase Description, Appendix C) reflect the findings of the T&E effort thus insuring that a standard design will satisfy Air Force reliability and maintainability requirements for commercial Halon 1211 units."

NEW EXTINGUISHERS.

During the conduct of this program, the author became familiar with three extinguishers not currently commercially available (at least in small size). These extinguishers have not yet undergone in-depth testing in the United States but may ultimately have some application to civilian aviation and should be evaluated for such use. The extinguishers are:

1. Extinguishers employing Halon 1211 - Halon 1301 mixtures - These units are currently being evaluated in mixtures varying from 90-10 to 50-50 Halon 1211 - Halon 1301 respectively. It is conceivable that some optimum mix and horn/orifice design may exhibit the desirable range and directionability of Halon 1211 with somewhat reduced toxicity.
2. High Expansion Foam Extinguishers - The smallest of these prototype units currently is a 2 1/2 gallon size (Figure 15). They deliver 150 ft³ of 300 to 1 expansion foam at a 75 cfm rate. The developer (MSA Research Corporation) has indicated that there would be no problem in making smaller units. In addition to providing more efficient cooling than 1211, 1301, CO₂ or Dry Chemical, the following potential advantages for aircraft application are stated by the manufacturer.

"Foam is a water-based suppressant system possessing all the attributes of water for fire extinguishment but with the advantage that the effective volume is up to 300 times that of the stored volume. Foam is an effective scrubber for fumes and smoke. Foam blankets over smoldering fires, such as in upholstery, reduces smoke emission while providing a low surface tension water solution for penetration into the fire area. Given the confinement of an aircraft cabin in flight and the toxic products released by the materials of construction of paneling and cushioning in the cabin, the ability to restrict smoke release would appear to be significant."
3. Solid Aqueous Film Forming Foam (AFFF) Extinguishers - These units utilize a replaceable solid AFFF cartridge housed in a special delivery nozzle (Figure 16) attached to a stainless steel tank charged with water. When the unit is activated, the flow of water through the cartridge rapidly dissolves the solid AFFF concentrate to produce AFFF solution. The extinguisher is currently only made in a 2 1/2 gallon size but discussion has indicated that the concept should work with smaller units.



FIGURE 15 MSA HIGH EXPANSION FOAM EXTINGUISHER

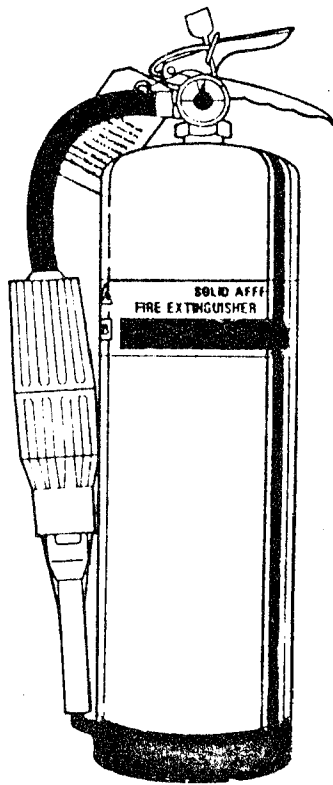

FIGURE 16 3M/AMEREX SOLID AFFF EXTINGUISHER

EXTINGUISHER HOSE/WAND.

It has been suggested that the addition of a hose to Halon 1211 extinguishers for cabin application would significantly increase their overall capability. This would probably be true for incidents in the overhead and incidents in locations where an unskilled operator might tend to turn the extinguisher upside down (i.e., under seats). Disadvantages of this concept have been stated as the need for two-hand operation and the probable inability of a hosed unit to fit in many spaces currently provided for extinguisher mounting. Fire statistics do not indicate a high frequency of overhead or under-seat incidents. However, a hose or wand could improve capability for certain galley type fires. A closer evaluation of potential advantages would be worthwhile and might lead to at least one unit being so equipped as a compromise. It should be recognized that Underwriters' Laboratories currently has a proposal to require a hose on all pressurized hand-held extinguishers with a rating of 2B or greater.

SMOKE GOGGLES FOR GENERAL AVIATION AIRCRAFT.

Fatal in-flight fires in general aviation aircraft are often the secondary result of the pilot's loss of aircraft control due to incapacitating fumes or fire (reference 42). Smoke goggles or even portable oxygen masks would not only minimize the effect of products of combustion, but would allow for longer soak times before ventilation becomes necessary in the event Halon 1301 were utilized on an in-flight cabin fire.

REFERENCES

1. U.S. Air Carrier Accidents Involving Fire, 1965 Through 1974, and Factors Affecting The Statistics, Bureau of Technology, NTSB, Washington, D.C. 20594, NTSB-AAS-71-1, February 17, 1977.
2. Starrett, P., Lopez, E., Silverman, B., Susersky, J., and Logan, J., Feasibility and Tradeoffs of a Transport Fuselage Fire Management System, Lockheed-California Co., Burbank, California 91520, For: U.S. Department of Transportation, FAA, FAA-RD-76-54, April 1976.
3. Accident Involving The Boeing 707 PP-VJZ of The Varig Company, Saulx-Les-Chartreux July 11, 1973, Office of the Secretary of State for Transportation, December 1975.
4. Stuckey, R.N., Supkis, D.E., and Price, L.J., Full-Scale Aircraft Cable Flammability Tests of Improved Fire-Resistant Materials, Lyndon B. Johnson Space Center, Houston, Texas 77058, NASA Technical Memorandum JSC-09060, NASA TMX-58141, June 1974.
5. Stuckey, R.N., Bricker, R.W., Kuminecz, J.F. and Supkis, D.E., Full-Scale Aircraft Cabin Flammability Tests of Improved Fire-Resistant Materials-Test Series II, Lyndon B. Johnson Space Center, Houston, Texas 77058, NASA Technical Memorandum JSC-10613, NASA TMX-58172, April 1976.
6. Bricker, R.W., Stuckey, R.N., Kuminecz, J.F., Bond, A.C., Aircraft Seat Cushion Materials Tests, NASA, LBJ Space Center, Houston Texas, Test Report JSC 09929, October 8, 1975.
7. Sarkos, C.P., Spurgeon, J.C. and Nicholas, E.B., Laboratory Fire Testing of Cabin Materials Used in Commercial Aircraft, FAA National Aviation Facilities Experimental Center, Atlantic City, N.J., From: J. Aircraft, Vol. 16, No. 2, 79-4025.
8. Gaume, J.G., Animal Exposure During Burn Tests, Douglas Aircraft Co., For: NASA, NASA CR 137802, NAS2-8668, January 1976.
9. Klinck, D.M., Characterization of Secondary Ignition Sources in Unattended Compartments and Full-Scale Baseline Test, Douglas Aircraft Company, For: LBJ Space Center, Houston, Texas 77058, NAS 9-14949, November 1977.
10. Fire Safety Aspects of Polymeric Materials, Volume 6, Aircraft: Civil and Military, A report by National Materials Advisory Board, National Academy of Sciences, 1977.
11. Data from Aircraft Passenger Seat Fire Tests Performed August 1980, Fire Safety Branch FAA Technical Center.
12. Smoke & Flame Characteristics of A/C Interior Furnishings, American Airlines Int. Report No. 221-80 (Internal), August 21, 1980 and Int. Report No. 224-80, August 25, 1980.

13. Boris, P.H., Young R.S., and Filipczak, R.A., Advanced Fire Extinguishers for Aircraft Habitable Compartments, : FAA National Aviation Facilities Experimental Center, Atlantic City, N.J., FAA-NA-78-47, May 1977, June 1978.
14. Jones, J.R., An Evaluation for the Location and Type of Hand Portable Fire Extinguisher Used on Board the AH-1 Helicopter, USMC Intern Training Center, Dept. of Safety Engineering, AD-A009 316, Available from: NTIS, April 1975.
15. Todd, A.S., Industrial Hygiene Survey for Halon 1211, Stewart-Todd Assoc., Inc., For: DOT USCG, Washington, D.C. DOT-CG-909131 - A Report No. 12080, February 20, 1981.
16. The Discharge of BCF (Halon 1211) Hand Extinguishers in Confined Spaces, Imperial Chemical Industries Limited, Mond Division.
17. Eight Flight Test Reports, Two FAA Type Inspection Authorizations, Correspondence and Personal Discussions with William Enk, Vice President Enk Aviation Corporation
18. Halon 1301 Fire Extinguishing Systems 1980, NFPA Standard 12A, November 20, 1980.
19. Halon 1211 Fire Extinguishing Systems 1980, NFPA Standard 12B, November 20, 1980.
20. An Appraisal of Halogenated Fire Extinguishing Agents, National Academy of Sciences Symposium, April 11-12, 1972, Section II Toxicology.
21. Chambers, W.H. and Krackow, E.H., An Investigation of the Toxicity of Fire Extinguishing Liquids. Part I. Summary, Medication Division Research Report No. 23, Chemical Corps, Army Chemical Center, Md., 1950.
22. Comstock, C.C., McGrath, F.P., Goldberg, S.B., and Lawson, L.H., An Investigation of the Toxicity of Proposed Fire Extinguishing Fluids. Part II. The Approximate Lethal Concentration to Rats by Inhalation of Vapors for 15 Minutes, Medical Division Research Report No. 23, Chemical Corps, Army Chemical Center, Md., 1950.
23. MacNamee, J.K., An Investigation of the Toxicity of Proposed Fire Extinguishing Fluids. Part III. The Pathology in Rats Produced by Inhalation of Proposed Fire Extinguishing Fluids, Medical Division Research Report No. 23, Chemical Corps, Army Chemical Center, Md., 1950.
24. Thorne, P.F., A Review of the Toxic Properties of Some Vaporizing Liquid Fire Extinguishing Agents, Fire Research Note 659, April 1967.
25. Thorne, P.F., The Toxicity of Halon Extinguishing Agents - A New Appraisal, Fire Research Station, Research Note 1073, October 1977.
26. The Effect of Bromotrifluoromethane (Halon 1301) on Human Performance, The Department of Environmental Medicine, The Medical College of Wisconsin, Montedison S.P.A. Milan, Italy, July 1973.
27. Stewart, R.D., Newton, P.E., Wu, A., Hake, C.L., and Krivanek, N.D., Human Exposure to Halon 1301, Department of Environmental Medicine, The Medical College of Wisconsin, June 1978.

28. Botteri, B.P., Cretcher, R.E., and Kane, W.R., Aircraft Applications of Halogenated Hydrocarbon Fire Extinguishing Agents, Wright Patterson Air Force Base.
29. Van Stee, E.W., Major USAF, A Review of the Toxicology of Halogenated Fire Extinguishing Agents, Aerospace Medical Research Lab, Available through NTIS, AD-A011 538, November 1974.
30. Hine, C.G., Elliott, H.W., Kaufman, J.W., Leung, S., and Harrah, M.D., Clinical Toxicologic Studies of Freon FE 1301 Proc. 4th Annual Conference Atmos. Contamination in Confined Spaces, AMRL-TR-68-175D: 127-144, Aerospace Medical Research Laboratory, Aerospace Medical Div., Air Force Systems Command, Wright Patterson Air Force Base, Ohio.
31. Call, D.W., Human and Rat Exposures to Halon 1301 under Hypobaric Conditions, Crew Systems Department, Naval Air Development Center, NADC-72125-CS, July 19, 1972.
32. Clark D.G., The Toxicity of Bromotrifluoromethane (FE 1301) in Animals and Man, Imperial Chemical Industries Ltd., Industrial Hygiene Research Laboratories, Cheshire, England (Unpublished Report), 1970.
33. Graham, R.C., Report on Bromotrifluoromethane (1301), Haskell Laboratory, DuPont, March 6, 1978.
34. Reinhardt, C.F. and Stopps, G.J., Human Exposures to Bromotrifluoromethane, E. I. duPont de Nemours & Company, Haskell Laboratory for Toxicology and Industrial Medicine, Report No. 230-66, Newark, DE (Unpublished), 1966.
35. Beck, P.S., Clark, D.G., and Tinston, D.J., The Pharmacological Actions of Bromochlorodifluoromethane (BCF), Toxicol. Appl. Pharmacol 24, 20-9 (1973).
36. Stewart, R.D., Peterson, J.E., Hosko, M.J., Newton, P.E., Dodd, H.C., and Baretta, E.D., Effects of Low Concentrations of Halon 1211 on Human Performance.
37. Clark, D.G., The Toxicity of Bromochlorodifluoromethane (BCF) to Animals and Man, Report No. HO/IH/R/279 ICI Ltd., Industrial Hygiene Laboratories, February 1970.
38. Graham, R.C., Report on Bromochlorodifluoromethane (1211) Haskell Laboratory, FOR DUPONT USE ONLY, January 23, 1978.
39. Hill, R., Inflight Aircraft Seat Fire Extinguishing Tests. (Cabin Hazards Measurements), FAA, to be published in 1982.
40. Hollingsworth, H.M., Obstructed Fire Tests on Hand-Held Fire Extinguishers for Recreational Boats, U.S. Coast Guard Research & Development Center, Avery Point, Groton, CT 06340, CG-D-133-75, Available from NTIS, May 1975.
41. Walker, J. and Vickers, R.N., Test and Evaluation of Halon 1211 Hand-Portable Fire Extinguishers for Use in Habitable and Cargo Compartments of USAF Aircraft, Final Report November 1981, Engineering Services Laboratory, Air Force Eng. and Services Center, Tyndall Air Force Base, Report No. ESL-TR-81-22.
42. Fire in the Cabin. How to Get Down and Out Alive, FAA General Aviation News, May-June 1981.

BIBLIOGRAPHY

Aircraft Cabin Fires, Business and Commercial Aviation, December 1974.

Atallah, S., Buccigross, H.L., Arons, I.J., and Valentine, J.R., Development of Halogenated Hydrocarbon Foam (Halofoam) Extinguishants, Arthur D. Little, Inc., For: A.F. Aero Propulsion Lab., A.F. Systems Com., Technical Report AFAPL-TR-71-21, April 1971.

Atallah, S., Hagopian, J.H., and Kalelkar, A.S., Advanced Fire Extinguishers for Aircraft Habitable Compartments, Arthur D. Little, Inc., For: Air Force Aero Propulsion Lab., A.F. Systems Command, Wright-Patterson Air Force Base, Ohio, Technical Report AFAPL-TR-72-62, June 1972.

Atallah, S., et al, Evaluation of Auxiliary Agents and Systems for Aircraft Ground Fire Suppression - Phase II. Arthur D. Little, Inc. for Aeronautical Systems Division, May 1974 (available from NTIS, Springfield, VA 22151, AD 78924).

Back, K.E., et al, Special Aspects of Aviation Occupational Medicine--Cardiovascular and Nervous System Effects of Bromotrifluoromethane, Advisory Group for Aerospace Research and Development, Paris, France, November 1972. Advisory Group for Aerospace Research & Development, Report No. 599, Dist. by NTIS.

BCF Bromochlorodifluoromethane for Use in Fire Extinguishers, Imperial Chemical Industries Ltd., Mond Div., Technical Service Note No. TS/C/2133/1.

Beene Jr., D.E., and Richards, C., Portable Extinguisher Evaluation for Coast Guard Cutters, U.S. Coast Guard R&D Center, Avery Point, Conn. 06340, Technical Report USCG-D-9-79, July 1978.

Carhart, H.W., and Fielding, G.H., Applications of Gaseous Fire Extinguishants in Submarines, Naval Research Laboratory - Paper published in "An Appraisal of Halogenated Fire Extinguishing Agents," National Academy of Sciences Symposium, April 11-12, 1972.

Coulston, F., and Griffin, T.B., Study of Toxicological Evaluation of Fire Suppressants and Extinguishers, Albany Medical College, March 1975. Available from NTIS, Springfield, VA 22161.

Crane, C.R., Human Tolerance Limit to Elevated Temperature: An Empirical Approach to the Dynamics of Acute Thermal Collapse, FAA Memorandum Report No. AAC-114-78-2, May 5, 1978.

Crane, C.R., Sanders, D.C., Endicott, B.R., Abbott, J.K., and Smith, P.W., Inhalation Toxicology: I. Design of a Small-Animal Test System, II. Determination of the Relative Toxic Hazards of 75 Aircraft Cabin Materials, FAA Civil Aeromedical Inst., Oklahoma City, For: Office of Aviation Medicine, FAA, Washington FAA-AM-77-9, March 1977.

Deus, H.R., Toxicity of BCF Fire Extinguishing Agents, SAFE Journal Vol. 8, No. 3, Fall of 1978.

Factory Mutual Approvals and Approval Standards.

Hand Fire Extinguishers for Use in Aircraft, DOT Advisory Circular AC 20-42A, FAA, July 29, 1980.

Hand Fire Extinguishers in Transport Category Airplanes and Rotorcraft, FAA Advisory Circular AC No. AC 20-42, DOT September 1, 1965.

Haun, C.C., Vernot, E.H., MacEwen, J.D., Geiger, D.L., McNerney, J.M., and Geckler, R.P., Inhalation Toxicity of Pyrolysis Products of Monobromomonochloromethane (CB), and Monobromotrifluoromethane (CBrF₂), Aerojet-General Corp., March 1967, AD 652850.

Kuchta, J.M., Martindill, G.H., and Spolan, I., Reactivity of Titanium with Selected Halogenated Hydrocarbons Used as Fire Extinguishing Agents, U.S. Bureau of Mines, Technical Report AFAPL-TR-66-81, Distributed by: Defense Technical Information Center, Cameron Station, Alexandria, Virginia 22314, June 1966.

Miller, M.J., and Kenney, J.M., Bibliography of Halon Literature, Factory Mutual Research Corporation, May 1978.

National Fire Protection Administration (NFPA) documents:

NFPA 10 Portable Fire Extinguishers 1978

NFPA 12A Halon 1301 Fire Extinguishing Systems 1980

NFPA 12B Halon 1211 Fire Extinguishing Systems 1980

NFPA 12 Carbon Dioxide Fire Extinguishing Systems 1980

NFPA 17 Dry Chemical Fire Extinguishing Systems 1980

NFPA 408 Aircraft Hand Fire Extinguishers (currently in draft revision).

Pusey, J.C., Prater, D., and Corrie, J.G., An Evaluation of Hand Portable Foam Type Fire Extinguishers, Fire Research Station, Fire Research Note No. 1049, March 1976.

Recommendations Concerning Airport Crash Fire-Fighting Vehicles, Airport Crash Response Capability, Rescue and Fire Committee Position Papers, ALPA, April 1981.

Simpson, C.G., Interrelationship of FAA-DOT-NASA Programs Relating to Aircraft Cabin Materials Fire, Federal Aviation Administration, AD-768-845, September 1973, Available from NTIS.

Smith, P.W., Aviation Toxicology Laboratory, AAC-114, Civil Aeromedical Ins., Letter to: DOT-FAA Mr. Glenn L. Martin, May 3, 1977.

Underwriters' Laboratories Documents:

UL 711 Rating and Fire Testing of Fire Extinguishers 1979

Current Listings and Safety Standards

Vanderburg, W.P.J., What's New in ALSE? Airborne Portable Fire Extinguishers, Flight Comment No. 3, 1980.